

# EDN<sup>®</sup>

ELECTRONICS DESIGN NETWORK

APRIL **19**  
Issue 8/2012  
[www.edn.com](http://www.edn.com)



Tales from the Cube:  
Smack attack Pg 58

Baker's Best Pg 18

The significance of  
poles and zeros Pg 20

Design Ideas Pg 46

Shipping now:  
conflict-free parts Pg 52

## CONTROLLER ICs TAKE MULTITOUCH SCREENS BEYOND SMARTPHONES

Page 30

Pico-projector design uses color LEDs

Page 23

Teardown: the nuances of variable-frequency drives

Page 41



**NEW  
PRODUCTS  
ADDED DAILY**

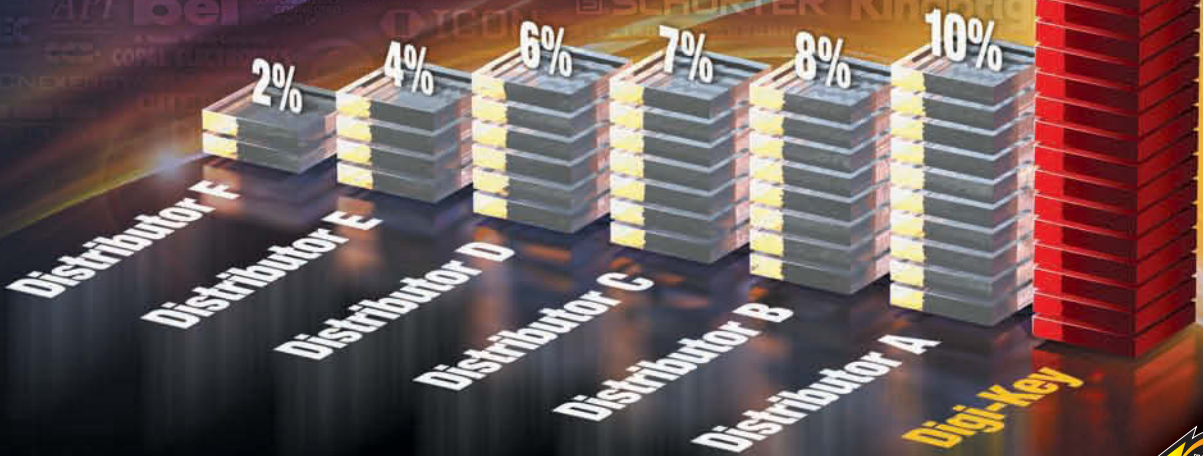
**[DIGIKEY.COM/NEW](http://DIGIKEY.COM/NEW)**



# BEST of CLASS!

Which single distributor comes to mind as being 'best of class' for broadest overall product selection?

SOURCE: 2011 DESIGN ENGINEER AND SUPPLIER INTERFACE STUDY, HEARST BUSINESS MEDIA ELECTRONICS GROUP



1.800.344.4539  
**DIGIKEY.COM**

2 MILLION PARTS ONLINE | 500+ INDUSTRY-LEADING SUPPLIERS | NEW PRODUCTS ADDED DAILY

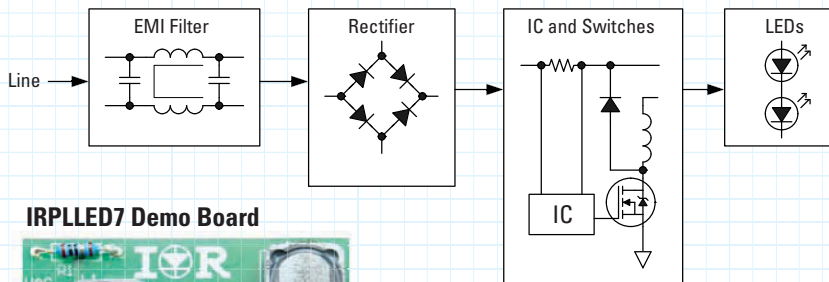
Digi-Key is an authorized distributor for all supplier partners. New products added daily. © 2012 Digi-Key Corporation, 701 Brooks Ave. South, Thief River Falls, MN 56701, USA



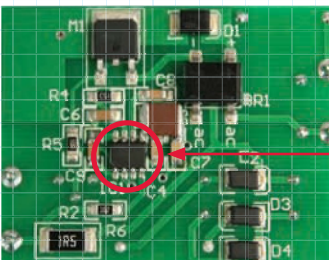
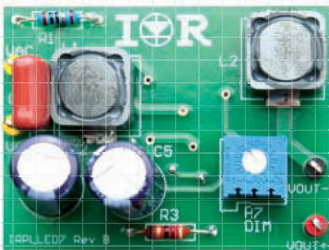
# LEDrivIR™



## High-Voltage Buck Control ICs for Constant LED Current Regulation

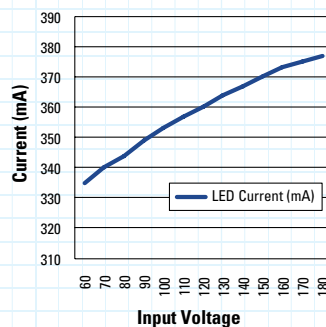


IRPLED7 Demo Board



LEDrivIR™  
IRS2980

IRPLED7 Demo Board  
LED Current vs Input Voltage



### IRS2980 Features

- Internal high voltage regulator
- Hysteretic current control
- High side current sensing
- PWM dimming with analog or PWM control input
- Free running frequency with maximum limiting (150kHz)

### IRS2980 Benefits

- Low component count
- Off-line operation
- Very simple design
- Inherent stability
- Inherent short circuit protection

### Demo Board Specifications

- Input Voltage 70V to 250V (AC)
- Output Voltage 0V to 50V (DC)
- Regulated Output Current: 350mA
- Power Factor > 0.9
- Low component count
- Dimmable 0 to 100%
- Non-isolated Buck regulator

Part Number	Package	Voltage	Gate Drive Current	Startup Current	Frequency
IRS2980S	SO-8	450V	+180 / -260 mA	<250 $\mu$ A	<150 kHz
IRS25401S	SO-8	200V	+500 / -700 mA	<500 $\mu$ A	<500 kHz
IRS25411S	SO-8	600V	+500 / -700 mA	<500 $\mu$ A	<500 kHz

for more information call 1.800.981.8699 or visit us at [www.irf.com](http://www.irf.com)

International  
**IR** Rectifier  
THE POWER MANAGEMENT LEADER



# “Superinductors”

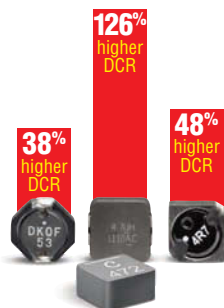


## That’s what engineers are calling our new ultra-low DCR power inductors

Superconductors pass current with virtually no resistance.

Our new XAL/XFL inductors do much the same. Their DCR is incredibly low: often half that of similar size parts.

And their current handling is equally impressive. Coilcraft’s proprietary core material has a soft saturation characteristic that



*Competitors' 4.7uH inductors have much higher DCR per mm<sup>3</sup> than Coilcraft's XAL5030.*

prevents drastic inductance drops during current spikes.

Unlike competitive parts, these inductors don't suffer from thermal aging. And we give you far more footprint options to maximize PCB density.

To see what else makes our new XAL/XFL inductors so super, visit [coilcraft.com/xal](http://coilcraft.com/xal).

**Coilcraft**

WWW.COILCRAFT.COM

 [coilcraftdirect.com](http://coilcraftdirect.com)  
No min order. Next day delivery.





# EDN contents

4.19.12



## Pico-projector design uses color LEDs

**23** An LED light source uses a flexible chip and package platform for color-sequential embedded pico projection.

*by Francis Nguyen and Stefan Morgott,  
Osram Opto Semiconductors GmbH*

## Controller ICs take multitouch screens beyond smartphones

**30** As multitouch touchscreens move beyond smartphones and tablets into automotive, medical, and instrumentation applications, their features evolve to fit lower prices and varying form factors.

*by Margery Conner, Senior Technical Editor*

## Teardown: the nuances of variable- frequency drives

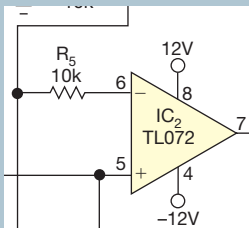
**41** Get an inside view of induction-motor control by varying frequency using PWM.

*by Steve Taranovich,  
Senior Technical Editor*



COVER IMAGE: THINKSTOCK/GIULIA FINI-GULOTTA

## DESIGN IDEAS



**46** Convert 1 to 5V signal to 4- to 20-mA output

**47** Linearize optical distance sensors with a voltage-to-frequency converter

**50** Use a transistor as a heater

**51** Monitor circuit conserves battery energy

► Find out how to submit your own Design Idea: <http://bit.ly/DesignIdeasGuide>.

AS9120A Certified Distributor →

**M**™ **mouser.com**  
Semiconductors and electronic  
components for design engineers.

Authorized Distributor



## Highest Standard for Quality and Control.

Mouser has high-level traceability and anti-counterfeit controls to serve aerospace, industrial, and commercial products. Your one source for What's Next.

- Widest selection of newest products
- Fastest introduction of new products
- Millions of products online
- 2000+ microsites and resources
- Localized global support
- Accurate, same-day shipping



**M**™ **mouser.com** | The Newest Products for Your Newest Designs®



a tti company



pulse



Dilbert 14

12 62.8-GHz-bandwidth DSO has 75-fsec-rms jitter-noise floor

14 Analog front ends bridge NDIR gas, pH-sensing transducers, microcontrollers

14 PIC expansion brings integrated analog and digital to 8-bit microcontrollers

15 Quad digital-power-supply manager has powerful GUI

16 **Voices:** Sage words of advice from Forte Design Systems founder John Sanguinetti

DEPARTMENTS & COLUMNS



54



58

9 **EDN online:** Join the conversation; Content; Engineering Community

10 **EDN.comment:** Before “exceptionalism” comes “can-do-ism”

18 **Baker’s Best:** EMI problems? Part three: strength of EMI-radiated signals

20 **Mechatronics in Design:** The significance of poles and zeros

52 **Supply Chain:** Shipping now: conflict-free parts; Hard-disk-drive-industry growth hits reset button

54 **Product Roundup:** Circuit Protection

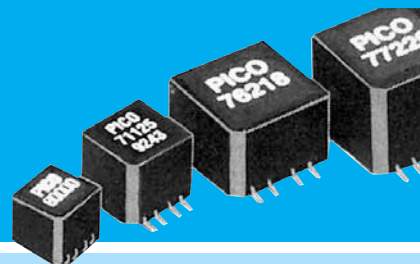
58 **Tales from the Cube:** Smack attack

EDN® (ISSN# 0012-7515) is published semimonthly by UBM Electronics, 600 Community Drive, Manhasset, NY 11030-3825. Periodicals postage paid at Manhasset, NY, and at additional mailing offices. SUBSCRIPTIONS—Free to qualified subscribers as defined on the subscription card. Rates for nonqualified subscriptions, including all issues: US, \$150 one year; \$250 two years; \$300 three years. Except for special issues where price changes are indicated, single copies are available for \$10 US and \$15 foreign. For telephone inquiries regarding subscriptions, call 847-559-7597. E-mail: edn@meda.com. CHANGE OF ADDRESS—Notices should be sent promptly to EDN, PO Box 3609, Northbrook, IL 60065-3257. Please provide old mailing label as well as new address. Allow two months for change. NOTICE—Every precaution is taken to ensure accuracy of content; however, the publishers cannot accept responsibility for the correctness of the information supplied or advertised or for any opinion expressed herein. POSTMASTER—Send address changes to EDN, PO Box 3609, Northbrook, IL 60065-3257. CANADA POST: Publications Mail Agreement 40612608. Return undeliverable Canadian addresses to APC, PO Box 503, RPO West BVR CRE, Rich Hill, ON L4B 4R6. Copyright 2012 by UBM. All rights reserved. Reproduction in whole or part without written permission is prohibited. Volume 57, Number 8 (Printed in USA).

PICO

ULTRA MINIATURE

Surface Mount Audio Transformers



Low Profile from .24"ht.

See full Catalog immediately [www.picoelectronics.com](http://www.picoelectronics.com)

- Manufactured and tested to MIL-PRF-27
- Frequency range 20 Hz to 250 KHz
- Available from 100 milliwatts to 3 watts
- Impedance from 20 ohms to 100 K ohms
- Operating temperature -55°C to +130°C
- Low Profile from .24"ht.
- Thru-Hole available

Delivery-Stock to one week for sample quantities



See EEM or send direct

for FREE PICO Catalog Call toll free 800-431-1064

in NY call 914-738-1400 Fax 914-738-8225

**PICO Electronics, Inc.**  
143 Sparks Ave., Pelham, N.Y. 10803  
E Mail: [info@picoelectronics.com](mailto:info@picoelectronics.com)

# 1 GHz never looked this good.



## Oscilloscopes Redefined

1 GHz starting at \$9,950\*\*

Agilent InfiniiVision X-Series oscilloscopes give you greater signal visibility thanks to patented MegaZoom IV technology. Waveform update rates more than 400x faster than the competition reveal elusive details and even infrequent events. Now get the power of InfiniiVision X-Series up to 1 GHz at amazingly affordable prices.

InfiniiVision Oscilloscopes	2000 X-Series	3000 X-Series*
Bandwidth* (MHz)	70, 100, 200	100, 200, 350, 500, 1 GHz
Update Rate (waveforms/sec)	>50,000	>1,000,000
Price** (starting at)	\$1,230	\$2,810

\*Existing 3000 X-Series oscilloscopes can now also be upgraded to 1 GHz  
\*\*Prices are in USD and are subject to change

**Agilent and our  
Distributor Network**  
Right Instrument.  
Right Expertise.  
Delivered Right Now.



800-433-5700  
[www.alliedelec.com/agilent](http://www.alliedelec.com/agilent)

**FREE WaveGen function/arbitrary waveform  
generator and digital voltmeter**  
[www.alliedelec.com/lp/agilentscopes/](http://www.alliedelec.com/lp/agilentscopes/)

© 2012 Agilent Technologies, Inc.

Anticipate — Accelerate — Achieve



Agilent Technologies



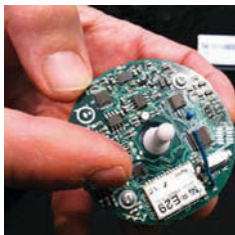


## JOIN THE CONVERSATION

Comments, thoughts, and opinions shared by *EDN's* community

In response to "Wi-Fi with LEDs, Bluetooth for iPhones, and wireless charging, all in one random walk," a blog post by *EDN's* Margery Conner, <http://bit.ly/HenHso>, Chris Gammell comments:

*"The technology and talking Bluetooth is really fun! However, I'm continually boggled as to how much crap designers put up with to design into Apple's market. It's brilliant and devious on their part."*



In response to "Patents: Where's yours (and how do you get them)?" a blog post by *EDN's* Patrick Mannion, <http://bit.ly/HYkLzM>, Steve comments:



*"I have 11 patents, or, rather, the company I work for has 11 patents with my name on them. My experience with the patent system is that it takes a long time, usually years, and it costs a lot of money. Not only does it cost a lot to file and then get the patent, there are the maintenance fees that seem to come up every year. It seems like with the*

*time and money it takes to get a patent, the process is pushing the small guy out. This, of course, reduces the workload on the patent office.*

*The amount of protection the patent provides depends on how well the application is crafted and if it needs to be filed in other countries. I think patents are a good thing, but the process needs to be more automated, and the cost needs to be significantly reduced."*

*EDN invites all of its readers to constructively and creatively comment on our content. You'll find the opportunity to do so at the bottom of each article and blog post. To review current comment threads on EDN.com, visit [http://bit.ly/EDN\\_Talkback](http://bit.ly/EDN_Talkback).*

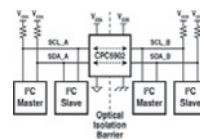


## CONTENT

Can't-miss content on EDN.com

### OPTICALLY ISOLATING AN I<sup>2</sup>C INTERFACE: BEWARE OF NONLINEAR PROPAGATION DELAYS

The usual model of an I<sup>2</sup>C open-drain bus as a simple, shared pull-up resistor is not instantaneously valid when using bus isolators exhibiting real-world propagation delays. If you don't consider delays when designing the hardware, there can be unexpected consequences.



<http://bit.ly/HKIU0q>

### ANOTHER ADVANTAGE OF LED LIGHTS: THEY DON'T ATTRACT BUGS, AND HERE'S WHY

Gary Trott, a product-development innovator for Cree LED Lighting, noticed that the LR6 down lights installed at the entrance to Cree four years ago had no bugs in them. This characteristic is remarkable for most lights. Find out why LED lights don't draw bugs in the way that incandescents do.

<http://bit.ly/HN2CcT>



## ENGINEERING COMMUNITY

Opportunities to get involved and show your smarts

### Maker Faire Bay Area

Get your do-it-yourself on at a two-day, family-friendly festival of invention, creativity, and resourcefulness, and a celebration of the grass-roots maker movement. Keep an eye out for *EDN's* Margery Conner at the event May 19 and 20, at the San Mateo County Event Center, 1346 Saratoga Drive, San Mateo, CA.

[makerfaire.com/bayarea/2012](http://makerfaire.com/bayarea/2012)

# Maker Faire



BY PATRICK MANNION, DIRECTOR OF CONTENT

## Before “exceptionalism” comes “can-do-ism”

**T**wo questions came up at the recent Design West conference: How do we rebuild America, and why did I come here? The first question arose during a panel session comprising UBM Electronics editorial leads. The point was to discuss and answer questions from attendees on major technology and trends in the electronics industry. As you might expect, topics went in about 2.3 microseconds from technology and engineering to jobs, education, and politics, with about a nanosecond in between on social media’s usefulness. The chat finished with a discussion on how we can go about rebuilding America.

I’ll provide my own take on rebuilding America by answering the second question: Why did I come here? This one comes up a lot because I am an immigrant. It’s hard to answer this question in a dinner setting, when all anyone wants to hear is a funny story. The personal and economical dynamics of the situation that was going on when I came to the United States were complex. On the face of it, I had no real reason to leave Ireland. I was 22, had a great job in Dublin, and was having fun with some good friends. It seems as though I had it made, until you define

“great.” At the time, “great” meant my job was reliable, could pay the bills, and left enough over for some weekend fun.

In reality, though, Ireland was a career dead end. In 1989, the year I left, it had an unemployment rate of 14.5% and seemed to be going nowhere (see **graph** of Ireland’s unemployment rate over three decades). Less than one year out of college, I got my first taste of unions, when a colleague said, “Take it easy; don’t work so hard.” Translation: “We have this company gamed, so don’t rock the boat.” Ireland was rife with such attitudes; I didn’t want any part of it.



Ireland’s unemployment rate went from “I’ve got to get out of here” in 1989 to “I have to go back” by 2004 to “Thank God I’m in the United States” by 2012.

Despite that attitude, some engineers there gave me great advice: “Travel now, son, while you’re young, or you’ll never get the chance again.” I looked at them, with the remorse of lost opportunity etched into every wrinkle of their faces, and my passport may as well have been already stamped. The plan was ... well, there was no real plan. Just start with New York for a few months and then go to California, Asia, Europe, and—maybe someday—back to Ireland again. My three months in New York turned into 22 years, a wife, two kids, and a dog.

How did it happen, and what does it have to do with rebuilding America? For that answer, I have to change the question to “Why did I stay?” versus “Why did I come?” Long before I heard and understood the term “American exceptionalism,” I knew and felt “American can-do-ism”: the sense that anything is possible that derives from a unique combination of optimism, confidence, freedom, work/reward ethic, self-reliance, and open markets. Coming from the dark into this kind of light was positively intoxicating.

Not all people manage to fully partake in this mix, but the possibility of partaking in it keeps the light alive. Over the past few years, a sense of doom has arisen, in part as a result of Sept 11 and the self-flagellating navel gazing it engendered and in part because of microeconomic and macroeconomic factors that have forever changed the employment landscape. That America is not the one I came to, and that foundation is not the one upon which to build the next surge of American can-do-ism. Fear has no place here; nothing good can come of it.

Recognizing when fear rears its ugly head, staring it down, and acting on the natural instincts toward rebirth and innovation that are the hallmarks of our nation will rebuild America. We have not yet determined how that rebuilding will take shape, but looking to Washington for help is the opposite of what made us great to begin with. Do we really want to keep doing that?**EDN**

Join the conversation at <http://bit.ly/HUJ4a>, or contact me at [patrick.mannion@ubm.com](mailto:patrick.mannion@ubm.com).



**SENIOR VICE PRESIDENT,  
UBM ELECTRONICS**

David Blaza  
1-415-947-6929;  
david.blaza@ubm.com

**DIRECTOR OF CONTENT,  
EDN AND DESIGNLINES**

Patrick Mannion  
1-631-543-0445;  
patrick.mannion@ubm.com

**EXECUTIVE EDITOR,  
EDN AND DESIGNLINES**

Rich Pell  
*Consumer*  
1-516-474-9568;  
rich.pell@ubm.com

**MANAGING EDITOR**

Amy Norcross  
*Contributed technical articles*  
1-781-869-7971;  
amy.norcross@ubm.com

**MANAGING EDITOR, ONLINE**

Suzanne Deffree  
*Electronic Business, Distribution*  
1-631-266-3433;  
suzanne.deffree@ubm.com

**SENIOR TECHNICAL EDITOR**

Margery Conner  
*Design Ideas, Power Sources,  
Components, Green Engineering*  
1-805-461-8242;  
margery.conner@ubm.com

**SENIOR TECHNICAL EDITOR**

Steve Taranovich  
*Analog, Systems Design*  
1-631-413-1834;  
steve.taranovich@ubm.com

**DESIGN IDEAS  
CONTRIBUTING EDITOR**

Glen Chenier  
edndesignideas@ubm.com

**SENIOR ASSOCIATE EDITOR**

Frances T Granville, 1-781-869-7969;  
frances.granville@ubm.com

**ASSOCIATE EDITOR**

Jessica MacNeil, 1-781-869-7983;  
jessica.macneil@ubm.com

**COLUMNISTS**

Howard Johnson, PhD, Signal Consulting  
Bonnie Baker, Texas Instruments  
Pallab Chatterjee, SiliconMap  
Kevin C Craig, PhD, Marquette University

**CONTRIBUTING TECHNICAL EDITORS**

Dan Strassberg, strassbergedn@att.net  
Brian Bailey, brian\_bailey@acm.org  
Robert Cravotta,  
robert.cravotta@embeddedinsights.com

**VICE PRESIDENT/DESIGN DIRECTOR**

Gene Fedele

**CREATIVE DIRECTOR**

David Nicastro

**ART DIRECTOR**

Giulia Fini-Gulotta

**PRODUCTION**

Adeline Cannone, Production Manager  
Laura Alvino, Production Artist  
Yoshihide Hohokabe, Production Artist  
Diane Malone, Production Artist

**EDN EUROPE**

Graham Prophet  
Editor, Reed Publishing  
gprophet@reedbusiness.fr

**EDN ASIA**

Huang Hua  
Operations General Manager  
huang.hua@ednasia.com  
Grace Wu  
Associate Publisher  
grace.wu@ednasia.com  
Vivek Nanda, Executive Editor  
vnanda@globalsources.com

**EDN CHINA**

Huang Hua  
Operations General Manager  
huang.hua@ednchina.com  
Grace Wu  
Associate Publisher  
grace.wu@ednasia.com  
Jeff Lu, Executive Editor  
jeff.lu@ednchina.com

**EDN JAPAN**

Masaya Ishida, Publisher  
mishida@mx.itmedia.co.jp  
Makoto Nishisaka, Editor  
mnishisa@mx.itmedia.co.jp

**UBM ELECTRONICS  
MANAGEMENT TEAM**

Paul Miller, Chief Executive Officer,  
UBM Electronics, UBM Canon (Publishing),  
UBM Channel, and UBM Design Central  
Kathy Astromoff,  
Chief Executive Officer, UBM Electronics  
Brent Pearson,  
Chief Information Officer  
David Blaza,  
Senior Vice President  
Karen Field,  
Senior Vice President, Content  
Jean-Marie Enjuto,  
Vice President, Finance  
Barbara Couchois,  
Vice President, Partner Services  
and Operations  
Felicia Hamerman,  
Vice President, Marketing  
Amandeep Sandhu,  
Director of Audience Engagement  
and Analytics

## Draw From Our Tool Box Of Customized Solutions

High reliability interconnect designs built for your application from prototype to production. Let us customize your solution today.



**ADVANCED  
INTERCONNECTIONS**

www.advanced.com  
401-823-5200

## Custom Front Panels & Enclosures



Sample price \$57.32 + S&H

Designed by you using our  
**FREE software, Front Panel Designer**

- Cost effective prototypes and production runs
- Powder-coated finish and panel thickness up to 10mm now available
- Choose from aluminum, acrylic or customer provided material
- 1, 3 and 5-day lead times available

**FRONT PANEL  
EXPRESS**

FrontPanelExpress.com  
(206) 768-0602



For a complete list of editorial contacts,  
see <http://ubmelectronics.com/editorial-contacts>

# pulse

INNOVATIONS & INNOVATORS

## 62.8-GHz-bandwidth DSO has 75-fsec-rms jitter-noise floor

With two of its four channels active and the maximum 2G-sample/active-channel acquisition memory, Agilent's new Infiniium 96204Q real-time-sampling DSO takes 160G samples/sec on each active channel. At that sampling rate, it captures 12.5-msec-long records. The rms jitter-noise floor is 75 fsec. You can use the four-channel scopes as two-channel instruments to obtain maximum bandwidth and minimum rise time. Agilent allows you to combine four scopes into a system that accommodates 16 33-GHz channels or eight 62.8-GHz channels, but the waveforms, along with time-reference markers, appear on four separate LCDs, each of which measures more than 15 in. diagonally.

The ADCs in Agilent's Q series are basically the same massively oversampling all-silicon converters the company has used for years in its high-end Infiniium scopes. To reduce spurious frequency components in each channel's 8-bit output data stream, Agilent has tweaked the algorithms that combine the many converter outputs.

A major obstacle to users' ability to take advantage of scope bandwidths greater than 30 GHz is the availability of probes. A quick check of the leading scope manufacturers' data sheets reveals no differential active probe with bandwidth greater than 30 GHz. Although you can make many ultra-high-frequency

measurements through direct connection to low-impedance scope inputs, the absence of suitable probes can complicate the task and force you to use pairs of channels to make differential measurements.

A key application for ultrawideband scopes with large numbers of channels is measurements on multilane fiber-optic communication systems. Such measurements require optical-to-electrical converters. Expect scope manufacturers to soon offer multichannel versions of these converters as front-end devices for these ultrawideband scopes.

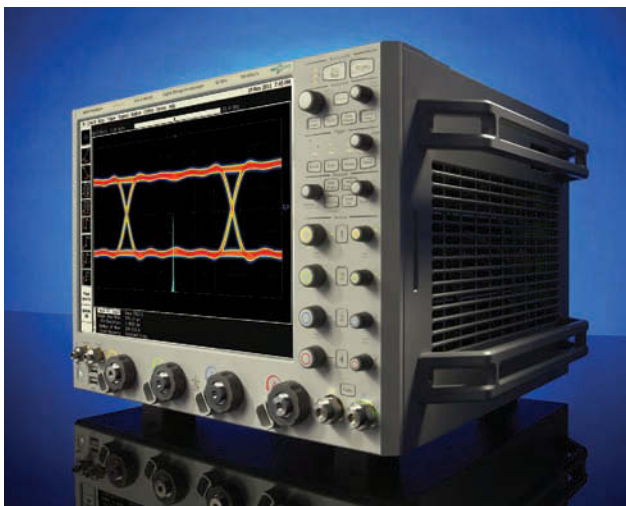
Prices for the Agilent 96204Q range from \$191,000 to \$419,000. Agilent has also introduced Infiniiview, a \$750 PC-based software package that enables users to go offline and manipulate and analyze data that scopes capture online. —by Dan Strassberg

▷ **Agilent Technologies,**  
www.agilent.com.

### ➔ TALKBACK

**"Some [primary manufacturers] like failures because they can charge to fix them. Now, if a counterfeit causes a problem, it's out of pocket with no chance to bill the taxpayers for it."**

—EDN reader A Kudravy, in EDN's Talkback section, at <http://bit.ly/HnBLnY>. Add your comments.



The Infiniium 96204Q real-time digital scope captures the fifth harmonic of the fundamental frequency of a square wave whose repetition rate is 12 GHz.



# Rarely Asked Questions

Strange stories from the call logs of Analog Devices

## The Electromotive Force and Op Amps

**Q:** Is it okay to run an op amp on a single +10 V supply, or do I need to use  $\pm 5$  V supplies?

**A:** This question comes up more often than an RAQ, but less often than a FAQ, so I figured it could stand some discussion. The answer is yes and no. Yes, you can use a +10 V supply; and no, you don't need to use bipolar  $\pm 5$  V supplies... unless you want to. Bipolar supplies can make life easier, but you must understand the implications of using each voltage scheme.

Whether you call it supply voltage, potential difference, or electromotive force (I like saying electromotive force, don't you?), the important thing to remember is that it is the voltage across the amplifier supply pins that matters. Op amps don't have ground pins, so they can't tell the difference between +10 V,  $\pm 5$  V, or +7 V and -3 V; in each case they see 10 V across the supply pins. The supply voltages determine the operating point of the amplifier, however. The operating point is typically the mid-supply voltage of the power supplies. In this case, +5 V for a single +10 V supply and 0 V for  $\pm 5$  V supplies.

Why mid-supply though? The input range and output swing are ultimately bounded by the supply rails. Operating an op amp at mid-supply maximizes both input dynamic range and output swing. Operating with bipolar supplies is easier, because most signal sources and loads are referenced to ground (0 V or mid-supply for symmetrical bipolar supplies). In this



case, the input signal source, output load, and op amp all have the same common reference point. When a single supply is used, however, the input and output range are shifted from 0 V, so a new operating point needs to be established. The new operating point can be anywhere within the amplifier's input range and output swing capabilities, but is usually centered on the mid-supply voltage to maximize input range and output swing. As you can imagine, this complicates things a bit, as the signal is now riding on a dc level (mid-supply voltage). This dc level can be isolated at input and output (ac coupling) or accommodated by the system.

When questions like this arise, it's always best to read the datasheet to understand the full implications of using amplifiers in single-supply applications. "May the force be with you," electromotive force, that is.



**Contributing Writer**  
John Ardizzoni is a Technical Product Manager at Analog Devices in the High Speed Linear group. John joined Analog Devices in 2002, he received his BSEE from Merrimack College in N. Andover, MA and has over 30 years experience in the electronics industry.

Have a question involving a perplexing or unusual analog problem? Submit your question to: [www.analog.com/askjohn](http://www.analog.com/askjohn)

For Analog Devices' Technical Support, Call 800-AnalogD

**To Learn More About Single-Supply Amplifiers**

<http://dn.hotims.com/40999-100>

SPONSORED BY



## Analog front ends bridge NDIR gas, pH-sensing transducers, microcontrollers

Though less glamorous than the various sensors now in consumer products, specialized transducers in the instrumentation world have amazing diversity in sensing real-world phenomena. Temperature, for example, is so basic yet requires so many types of sensors, which are available in thousands of styles. Two analog front-end ICs from Texas Instruments strive to greatly simplify the path between a sensor and its associated processor.

The LMP91050 for NDIR (nondispersive-infrared)-gas sensing supports multiple thermopile sensors for indoor carbon-dioxide monitoring, demand-control ventilation, heating/ventilation/air-conditioning, alcohol breath analysis,



The LMP91050 for nondispersive infrared gas sensing and the LMP91200 for pH sensing, both from Texas Instruments, provide highly integrated analog front-end interfaces between these specialized sensors and a system processor.

greenhouse-gas monitoring, and Freon detection. It integrates a programmable-gain

amplifier, “dark-phase”-offset-cancellation circuitry, an adjustable common-mode generator, and SPI to simplify system design. The internal PGA has low- and high-gain ranges so that you can use the device with thermopiles having different sensitivities.

Critical specifications include maximum gain drift of just 100 ppm/°C, output offset drift of 1.2 mV/°C, phase-delay variation of 500 nsec, noise of 0.1  $\mu$ V rms at 0.1 to 10 Hz, and operation at 40 to +105°C. The LMP91050 gas-sensing AFE is available in a 10-lead, 3x4.9-mm MSOP and sells for \$1.32 (1000).

The LMP91200 AFE for pH-sensing supports two-electrode pH sensors, which ana-

lyzer platforms often use for emissions monitoring, steam- and water-quality monitoring, chemical/petrochemical plants, and food processing. It integrates a PGA, an ultra-low-input-bias pH buffer, signal guarding, temperature and measurement calibration, and common-mode generation and diagnostics circuitry.

The IC operates from 1.8 to 5.5V and -40 to +125°C, with a guaranteed low-pH-buffer input-bias current across the operating range. It is available in a 16-lead, 5x6.4-mm TSSOP and sells for \$3.90 (1000). Both the LMP91050 and LMP91200 AFEs work with TI’s Webench Sensor AFE Designer software and bench-top development system. To order samples, visit [www.ti.com/sensorafe-pr](http://www.ti.com/sensorafe-pr).

—by Bill Schweber  
 ▶Texas Instruments, [www.ti.com](http://www.ti.com)

## PIC expansion brings integrated analog and digital to 8-bit microcontrollers

Microchip recently expanded its 8-bit PIC-16F(LF)178X microcontroller family to include an on-chip 12- or 10-bit ADC; as many as three op amps and four comparators; an 8-bit DAC; and a 16-bit PWM PSMC (programmable switch-mode controller) operating at 64 MHz, which helps with closed-loop control in

power supplies and lighting. The LF version features the company’s extreme low-power technology for active and sleep currents of 32  $\mu$ A/MHz and 50 nA, respectively. Target applications include LEDs, battery management, digital power supplies, and motor control. The devices operate as fast as 32 MHz and come with an internal oscillator,

3.5 to 14 kbytes of flash, 128 to 512 bytes of RAM, and 256 bytes of data EEPROM.

The PIC16F(LF)1782, 3, 4, 6, and 7 are available in SOICs, SPDIPs, QFNs, UQFNs, PDIPs, and TQFPs. Prices start at \$1.18 (10,000).

—by Patrick Mannon  
 ▶Microchip, [www.microchip.com](http://www.microchip.com).



The PIC16F(LF)178X midrange family of 8-bit microcontrollers now has an on-chip 12- or 10-bit ADC, as many as four comparators, an 8-bit DAC, and a programmable switch-mode controller.

### DILBERT By Scott Adams





## Quad digital-power-supply manager has powerful GUI

The LTC2974 power-supply manager from Linear Technology provides digital management of power-supply systems with four or more power rails. It uses an I<sup>2</sup>C interface and PMBus command set to monitor and control positive or negative supplies. The LTC2974's four channels simultaneously monitor voltage, current, and external temperature so that users can compensate for shifting MOSFET on-resistance or direct-current resistance.

Users can margin and trim each supply over temperature, using a digital servo loop that measures the rail voltage and continuously adjusts it to maintain accuracy. The supply functions provide better-than-±0.25% total unadjusted error. The LTpowerPlay GUI allows users to configure and interrogate the unit's registers, user settings, and fault log. Users can cascade the LTC2974 for applications requiring more than four supplies, using a one-wire synchronization bus, allowing the establishment of fault dependencies for devices sharing the fault bus.

Applications include uninterruptible power supplies, automobiles, and medical and video systems. A programmable watchdog timer supervises an external microcontroller, FPGA, or ASIC. Black-box fault logging provides a method of diagnosing failure at the time of fault. The LTC2974 comes in a 64-lead, 9x9-mm QFN package, and prices start at \$8.85 (1000). —by **Fran Granville**

► **Linear Technology**,  
www.linear.com/product/LTC2974.



The LTC2974 quad digital-power-supply manager supports multichannel fault management.

[www.edn.com]

## Click Here for Low-Cost Wi-Fi® and Wi-Fi® + Bluetooth® Combination Radio Modules

<http://www.rfm.com/>



### The WLS-Series Wi-Fi and Wi-Fi + Bluetooth Combination Modules from RFM Deliver High RF Performance and Small Form Factor... and We Mean *Really Small*

#### WLS1270

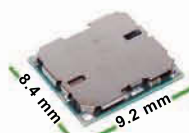
2.4 GHz  
802.11b/g/n



Wi-Fi Compliant Only

#### WLS1271L

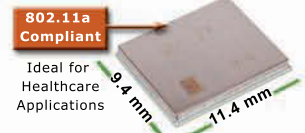
2.4 GHz  
802.11b/g/n



Wi-Fi and Bluetooth Compliant

#### WLS1273L

2.4 GHz & 5.8 GHz  
802.11a/b/g/n



#### Quickly Add Standards-Based Connectivity Into Products

Best-in-class WLAN and Bluetooth co-existence technology on a single-chip  
High-efficiency front-end circuits plus DC-DC converter  
Minimal external circuitry required to complete a radio design  
Software drivers are available for Linux, Android and WinCE

**NEW!**

Bluetooth v4.0  
Low Energy  
BLE

#### Easily Fits Into Small Spaces: Smaller Than a Dime Yet Features High Level of Integration

Embedded ARM microprocessor  
Supports SDIO host interfaces for WLAN

#### Efficiently Obtain Wi-Fi, Bluetooth, and FCC / ETSI Certification

WLAN: All three modules comply with IEEE 802.11b/g/n; WLS1273L complies with 802.11a/b/g/n  
Bluetooth: WLS1271L & WLS1273L modules comply with Bluetooth v4.0 + EDR, Power Class 1.5 + BLE  
FCC/ETSI: Like all RFM Short-Range Radios the WLS-Series modules are FCC and / or ETSI certifiable

#### WLAN Features

- IEEE 802.11 b/g/n compliant (WLS1273L 11a/b/g/n)
- Data Rates: 1-65 Mb/s
- Operating Freq Range: 2.412 to 2.485 GHz  
WLS1273L additionally operates at 4.920 to 5.825 GHz
- Output Power: up to 18 dBm

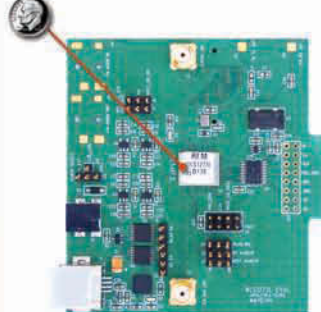
#### Bluetooth Features (WLS1271L & WLS1273L only)

- Bluetooth Version 4.0 plus EDR, Power Class 1.5
- Data Rate: up to 3 Mb/s
- Operating Freq Range: 2.4000 to 2.4835 GHz
- Output Power: up to 8 dBm
- Supply Current: 35 mA typical (DH1)

#### Just *how* small are we talking?

WLS1273L Module Installed on DR-WLS1273L-EV Evaluation Board

#### WLS1273L Combo Module Smaller than a Dime



#### Buy Your Evaluation Kit Today!

Available from RFM Distributors



Avnet Memec  
Digi-Key  
Future Electronics  
Mouser Electronics

Wireless is... **RFM**  
www.RFM.com

Evaluation Kit Part Numbers

DR-WLS1270-EV DR-WLS1271L-EV DR-WLS1273L-EV

## VOICES

### Sage words of advice from Forte Design Systems founder John Sanguinetti

John Sanguinetti, the founder and chief technology officer of Forte Design Systems, is an inventor, an entrepreneur, a cancer survivor, and an interesting guy. *EDN* spoke with him during the recent 2012 Design and Verification Conference in San Jose, CA. A portion of that discussion follows.

#### What is it about the EDA industry that you love, or do you still love it?

**A** I do still have a lot of affection for it, but "love" is too strong a word. The intellectual challenge still really appeals to me. What I don't like is the way in which the business has stagnated. It has a dysfunctional business model. But it is still a good industry for a start-up. You don't need to take too much investment money, and, as long as it doesn't take you too long to develop a product, you can then get bought out.

That part of the business is still fun. It has gotten harder. I have seen a product recently where it took five or six guys a couple of years to develop a product, and then Synopsys bought them, but that is not typical. All of the easy things have been done, and a product has to interface to so many things and has to fit into a complex flow. So, even if there are no unforeseen elements, it takes a long time.

#### If I were an entrepreneur starting up an EDA company, what advice would you give me?

**A** The biggest piece of advice is: Don't take too

much money. Don't start spending money on marketing or sales until you have something working. If you think you can raise money, hire a couple of guys, and be done in a couple of years, then you are probably being unrealistic. If you [take that approach], then you have to take more money, and the initial investors get diluted or wiped out, and that [scenario] is no fun for anybody.

With Forte, it took a long time to get the product really working, and the investors had to be patient. I have been on the boards of companies where it is clear that the investors are completely fed up with it and just want to get some kind of return. In EDA, you can get bought, but you can't expect to *sell* a company. Who are you going to sell it to? If investors start to think [that they are] going to sell a company, they end up giving it away.

#### How much money did Chronologic [Verilog Compiler Simulator] take?

**A** Zero. We didn't take any money, but you really can't do that anymore. We did it because there were only two of us, and my wife could support me. My partner



had put away some money as a design-and-verification consultant before we got started, and that [money] tided him over. We picked up a couple of other people along the way who didn't need to get paid immediately. It took us 15 months from start to first customer ship.

#### There are a lot of start-ups in the high-level synthesis space. Why do you think that it still doesn't seem to be taking off in the way that register-transfer-level synthesis did?

**A** It hasn't taken off in the way that register-transfer-level synthesis did, but it is growing. We just reported that we grew 30% last year, and we expect that growth to continue.

#### Originally, adoption was centered in Japan. Is that situation broadening?

**A** It is. It started in Japan for a couple of reasons. Mainly, it is because consumer devices were the sweet spot for high-level synthesis. The kinds of designs that high-level synthesis initially worked well with were image manipulation, and digital TV was one of the areas in which it [found use]. Putting image-manipulation algorithms into hardware is something that high-level syn-

**Q** In EDA, you can get bought, but you can't expect to *sell* a company. Who are you going to sell it to?

thesis has been good at, and most of these products were developed in Japan.

There were some other reasons, and [the following] is more opinion. People have been doing hardware design from C for a long time. A survey we did about 15 years ago asked if people were using C as the starting point for their design, and about 50% said yes. People in the United States managed to figure out how to go from C to Verilog, even though it was mostly a manual process.

Companies in Japan didn't start with C models. In the late '90s, Japan realized that it needed to [increase] abstraction and readily adopted SystemC because it didn't have any legacy [software]. But now, it is really growing in other parts of the world, including the United States. There were a number of early adopters in Europe, but Europe's [use of high-level synthesis] seems to have faded. In the United States, people knew that they had to do something, and nothing better than SystemC has come along.

#### Did you ever finish writing your memoirs?

**A** No, I didn't. I am not sure how much sanitizing I would have to do. [I've told] the main story, and there are all of the details, but I am not sure it would be a good idea to have those published.

—interview conducted and edited by Brian Bailey



# 您会说 MATLAB 吗?

Over one million people around the world speak MATLAB. Engineers and scientists in every field from aerospace and semiconductors to biotech, financial services, and earth and ocean sciences use it to express their ideas. Do you speak MATLAB?



*Solar Image taken by the X-Ray Telescope; supplied courtesy of Smithsonian Astrophysical Observatory.*

*See related article at [mathworks.com/ltc](http://mathworks.com/ltc)*

**MATLAB**®  
The language of technical computing



BY BONNIE BAKER

## EMI problems? Part three: strength of EMI-radiated signals

**H**ow far away from radiating sources do you need to be so that the radiated signal does not interfere with your system? As you answer this question, consider both the amount of radiated energy from a source and your system's electromagnetic-interference-protection circuitry. Radiating EMI signals propagate from a source to a receiving element (references 1 and 2). The power, or voltage level, of these signals as they hit your sensitive circuits depends on the transmitter's power and antenna gain and the distance between the source and the receiver (Figure 1).

Electric-field strength quantifies the magnitude of the interfering voltage at the source. This narrowband or broadband EMI signal unit of measure is in volts per meter. You can modify the units for the electric-field strength to your liking by converting them to decibels referenced to microvolts, where  $\text{dB}\mu\text{V} = 20\log(\text{V}) + 120 \mu\text{V}$ .

A narrowband EMI signal typically is a repetitive signal or pulse train. The equation in Figure 1 allows you to quickly get a worst-case prediction of the radiated voltage,  $E_R$ , at a specific distance from the EMI source. A broadband EMI

signal typically is a single pulse, such as a lightning strike, an electrostatic-discharge event, or a spark gap. These pulse-type events contain multiple frequencies. Broadband signals are difficult to measure because they are nonrepetitive and fast.

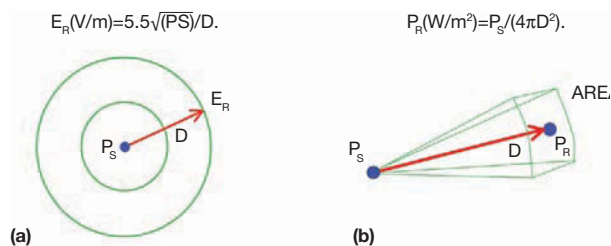
Radiated-power-density units can also describe narrowband events. The unit of measure for the EMI narrowband, radiated-power density is watts per square meter. Communications engineers use the power-density representation of an EMI signal for their narrowband EMI issues. You can convert the radiated-power-density units to decibels referenced to

milliwatts, where  $\text{dBm} = 10\log(\text{W})$ .

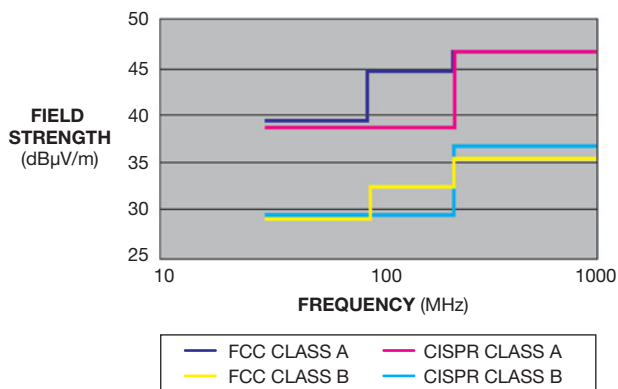
You can use an oscilloscope to observe EMI signals in the time domain and a spectrum analyzer to evaluate EMI signals in the frequency domain. However, FCC- and European CISPR-certified companies must perform all radiated EMI measurements before the release of their products to the market. This requirement ensures that the test results are accurate according to FCC or CISPR regulations. Test methods include environmental conditions, along with calibrated EMI test equipment and antennas. The FCC and CISPR require that the radiated signals that your equipment transmits comply with specified values. FCC- and CISPR-related documents include EN 55011, EN 55013, EN 55014, EN 55015, EN 55022, and EN 50081-1.2.

Figure 2 shows Class A limits for electronic equipment for use in commercial, industrial, or business environments. Class B limits apply to electronic equipment for use in the residential environment. Equipment in residential environments may also be subjected to the Class A limits. Class B limits are more restrictive because of the likelihood of the equipment's close proximity to TV and radio receivers.

We are getting close to the devices in your circuit. Next month's column will discuss EMI-conducted radiation. **EDN**



**Figure 1** The power, or voltage level, of these signals as they hit your sensitive circuits depends on the transmitter's power and antenna gain, the distance between the source and the receiver, and whether the circuit is using a narrowband EMI signal at electric-field strength (a) or a broadband EMI signal at radiated-power density (b).  $P_s$  is the source power in watts,  $D$  is the distance in meters,  $E_R$  is the receiver's electric-field level, and  $P_R$  is the receiver's power in watts.



**Figure 2** Class A limits are for electronic equipment for use in commercial, industrial, or business environments. Class B limits apply to electronic equipment for use in the residential environment.



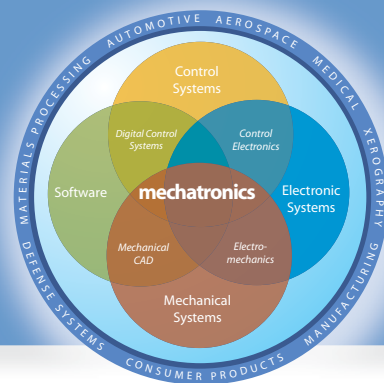


**Snap Dragon Only At MPD**  
**[www.batteryholders.com](http://www.batteryholders.com)**

**Patent pending    [sales@batteryholders.com](mailto:sales@batteryholders.com)    631-249-0001**

# MECHATRONICS IN DESIGN

FRESH IDEAS ON INTEGRATING MECHANICAL SYSTEMS, ELECTRONICS, CONTROL SYSTEMS, AND SOFTWARE IN DESIGN



## The significance of poles and zeros

Emulate Wilbur Wright and learn the significance of poles and zeros.

Wilbur Wright's understanding of complex, dynamic problems contributed to his and his brother Orville's successful first airplane flight. Wilbur understood, for example, that, to turn a bicycle to the left, you must first turn the handlebars a little to the right and then, as the bicycle inclines to the left, you must turn them a little to the left. He understood countersteering. In mathematical language, the transfer function between the steer torque applied to the handlebars and the straight-line-path deviation has a right-half-plane zero, which imposes a limit on maneuverability. The path deviation has an inverse-response behavior; that is, in response to a positive step-torque input you apply to the handlebars, the path deviation is initially positive and then becomes negative. This effect has contributed to numerous motorcycle accidents, but countersteering could prevent these accidents.

To better understand the physical significance of the poles and zeros of a transfer function, consider a simpler system, comprising two rigid links and a torsional spring (see **Figure 1**). Assume small displacements. The equations of motion, shown in the online version of this article at [www.edn.com/120419mech](http://www.edn.com/120419mech), are in matrix form, along with two transfer functions,  $G_0(s)$  and  $G_1(s)$ .

A pole of a transfer function is a value of  $s$  that makes the denominator equal to zero, and a zero of a transfer function is a value of  $s$  that makes the numerator equal to zero. Systems that have no poles or zeros in the right half of the complex plane are minimum-phase systems because either of the two components of the frequency response, gain and phase, contains all the frequency-response information that exists. This phenomenon, Bode's gain-phase relationship, stipulates that systems that have poles in the right half of the plane are unstable. A nonminimum-phase stable system is one that has a zero in the right half of the plane. Physical phenomena that give rise to nonminimum-phase stable behavior include control of

the level of a volume of boiling water and hydroelectric power generation.

The denominators of both transfer functions are identical. The double pole at the origin represents the rigid-body motion of the system. The complex-conjugate pole pair represents the natural frequency associated with the energy-storage characteristics, including kinetic and potential energy, of the physical system. They are independent of the locations of the sensor ( $\theta_0$  or  $\theta_1$ ) and the actuator (T). At a frequency of the complex pole, energy can freely transfer back and forth between the kinetic and the potential energy, and the system behaves as an energy reservoir.

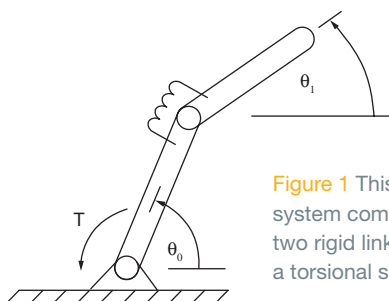
The numerators of the two systems differ greatly. The complex zero represents the natural frequency associated with the energy-storage characteristic of a subportion of the system.

The sensor and the actuator impose artificial constraints that define this subportion. These constraints include the resonant frequency of the second link when the first link is fixed. It is lower than the natural frequency of the system, and it corresponds to the frequency at which the system behaves as an energy sink, such that the energy-storage elements of a subportion of the original system completely trap the energy that the input applies. Thus, no output can ever be

detected at the point of measurement. The zero in the right half of the plane is a nonminimum-phase zero and gives rise to the same characteristic initial inverse response that Wilbur Wright observed in the bicycle. The locations of the poles and the zeros of a transfer function are the result of design decisions and can make control easy or difficult. **EDN**



Kevin C. Craig, PhD, is the Robert C. Greenheck chairman in engineering design and a professor of engineering at the College of Engineering at Marquette University. For more mechatronics news, visit [mechatronicszone.com](http://mechatronicszone.com).



**Figure 1** This system comprises two rigid links and a torsional spring.





# FIVE YEARS OUT.

**AVIATION:** More comfort, more safety, more innovation and of course, more electronics. Are you Five Years Out? Then you're probably working with us.

**ANW**  
Five Years Out

# Power your most demanding setups with ease.



## No matter your application, accelerate with Agilent.

Whether it's automotive ECU, military communications, base station power amplifiers or general purpose test, maximize manufacturing throughput and R&D productivity. With seven new high-power modules from 300 to 500 W, Agilent helps you execute a wide range of high-power setups with the performance to measure milliamps accurately, too.

### Agilent N6700 Modular Power System

- 4 mainframes—manufacturing or R&D
- 34 modules from 20 to 500 W
- 4 performance levels—basic to precision



To view application videos scan QR code



or visit <http://goo.gl/sgwbK>

Get a **FREE 8 GB USB drive** loaded with power product resources\*  
[www.agilent.com/find/N6700Power](http://www.agilent.com/find/N6700Power)

© Agilent Technologies, Inc. 2012. \*While supplies last. Terms and conditions apply.

u.s. 1-800-829-4444 canada: 1-877-894-4414

Anticipate —Accelerate —Achieve



Agilent Technologies





# PICO-PROJECTOR DESIGN USES COLOR LEDs

BY FRANCIS NGUYEN AND STEFAN MORGOTT •  
OSRAM OPTO SEMICONDUCTORS GMBH

**T**he first production LED-powered projector debuted in 2005, and a number of projectors with output of 5 to 15 lumens from various manufacturers followed. These new smaller projectors could easily fit into a briefcase but were still too large to fit into a jacket pocket (**Reference 1**). The units, weighing 0.21 to 1 kg, became known as pico projectors and could display an image large enough for a small audience in a dark room.

AN LED LIGHT SOURCE USES A FLEXIBLE CHIP AND PACKAGE PLATFORM FOR COLOR-SEQUENTIAL EMBEDDED PICO PROJECTION.

IMAGE: SHUTTERSTOCK; PRODUCTS COURTESY OF THEIR RESPECTIVE COMPANIES

In 2007, 3M began shipping the MP1xx series of pico projectors, ranging from the MP120, capable of 12-lumen output, to the MP180, with 30-lumen output. All of these stand-alone projectors included built-in batteries capable of two hours of runtime and of displaying still images and videos stored in onboard memory or from an external source.

Subsequently, other pico projectors emerged. These units were embedded in handheld appliances, such as digital still cameras, cell phones, and camcorders. To date, few cell phones with built-in projectors are on the market due to the cost, size, and battery drain that the addition of a projector causes.

A typical pico-projector design comprises an LED light source; collection optics, which direct the light from the LED to an imager; an imager, typically a DMD (digital micromirror device) or an LCOS (liquid-crystal-on-silicon) device, which accepts digital-display signals to shutter the LED light and direct it to the projection optics; output or projection optics, which project the display image on the screen and also permit functions such as focusing of the screen image; and control electronics, including the LED drivers, interfacing circuits, and the video and graphics processor (Figure 1).

## DESIGN CHALLENGES

For many LED applications, the total number of extracted lumens, or luminous flux, is the most important param-

### AT A GLANCE

For many LED applications, the total number of extracted lumens, or luminous flux, is the most important parameter.

For projection, the important parameter is not the total number but the usable number of LED lumens—that is, those that can be guided through the optical system.

The étendue of an LED is a property of pencils of rays in an optical system, which characterizes how spread out light is in area and angle.

Each projection optical system has a maximum usable light-emitting area of the LED. Beyond this maximum area, you cannot guide the additional light through the optical system.

eter. For projection, the important parameter is not the total number but the usable number of LED lumens—that is, those that can be guided through the optical system. For a pico-projector module embedded in a mobile appliance, the available electrical power is limited to a fixed value to ensure achieving the expected battery-operation time. The figure of merit, therefore, is the projector efficacy in lumens per watt. The LED source must meet the needs of the chip and package efficiency and match those of the projector's optical system.

Imagers' panel types, sizes, and

illumination architectures all require different types of LEDs for achieving maximum projector efficacy. Osram Opto Semiconductors has introduced LED chips with enhanced optocoupling features. These chips employ ThinFilm and ThinGaN chip technologies and have high inherent efficacies and surface-emitting properties. Red ThinFilm and green and blue ThinGaN chips use AlInGaP (aluminum-gallium-indium phosphide) and InGaN (indium-gallium nitride), respectively. Dominant wavelengths of 617, 525, and 460 nm project the spectral emission for red, green, and blue, respectively (Figure 2).

Figure 3 shows the relative efficacy, normalized to 100% at 350 mA/mm<sup>2</sup>, versus current density for ThinFilm and ThinGaN chips. The figure illustrates the relative efficacies in lumens per watt for standard chip sizes: 500 microns, 750 microns, and 1 mm, or 20, 30, and 40 mil, respectively. It shows that efficacies at 350 mA decrease with increasing current density. This so-called current droop is stronger for ThinGaN than for ThinFilm chips. Therefore, you achieve higher efficacy by selecting the maximum LED chip size.

Each projection optical system has a maximum usable light-emitting area of the LED. Beyond this maximum area, you cannot guide the additional light through the optical system. This quantity is useful for calculating the usable amount of light that can be guided through the projector optics sys-

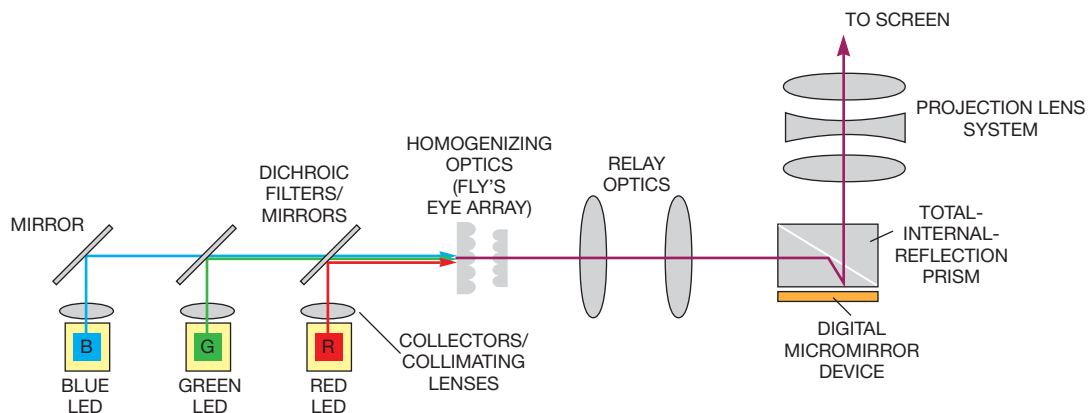


Figure 1 A typical pico-projector design comprises an LED light source, the collection optics, an imager, an output or projection optics, and control electronics.



# COMING TO A CITY NEAR YOU!

2012 **X**fest



**From April through September 2012, Avnet and Xilinx will co-host X-fest technical training events throughout Asia, Europe and North America.**

X-fest's in-depth curriculum offers a full-day of practical, how-to training for FPGA, DSP & embedded systems designers. The fully-customizable training experience allows attendees to pick up to four courses from any of the three unique training tracks.

#### **FPGA Fundamentals Track**

The FPGA Fundamentals track focuses on common design issues facing both new and advanced FPGA designers.

#### **Applications Track**

The Applications track delves deeper into design methodologies and techniques required when designing with the Zynq™-7000 Extensible Processing Platform (EPP) and 7 series FPGAs.

#### **Zynq-7000 EPP Track**

The Zynq-7000 EPP track provides four courses dedicated to the ARM® dual core Cortex™-A9 MPCore™ based device.

Register for a **FREE**  
**ALL ACCESS PASS**

[budurl.com/2012Xfest](http://budurl.com/2012Xfest)

#### **PARTNER DEMONSTRATIONS AND EXHIBITS**

Xilinx	Aldec
Avnet	ARM®
Analog Devices	MathWorks
Maxim	Spansion
Micron	FCI
TE Connectivity	Samtec
Texas Instruments	PLDA
Cypress Semiconductor	Ericsson

 **XILINX**®

2012 **X**fest


 **AVNET**®

Learn more at [budurl.com/2012Xfest](http://budurl.com/2012Xfest)

**DON'T MISS ANY X-FEST UPDATES.  
JOIN THE CONVERSATION TODAY!**

 @avnexfest

 facebook.com/xfest2012

 Join the Avnet X-fest group!

tem (Reference 2). It determines the maximum usable emitting area of the light source as it quantifies the spatial and angular extent of a light beam. The étendue of an LED is a property of pencils of rays in an optical system, which characterizes how spread out light is in area and angle:  $E=N^2A\Omega$ , where  $N$  is the refractive index of the medium,  $A$  is the emission area, and  $\Omega$  is the projected solid angle.

In an ideal optical system, the étendue is a constant throughout the optical path. You can neither decrease the étendue nor increase the luminance. The optical system's étendue—that is, the imager panel's size and the acceptance angle of the optical system—limits the LED's étendue:

$$E_{LED} \leq E_{SYSTEM}, \text{ and}$$

$$N^2 A_{LED} \sin^2 \theta_{LED} \leq A_P \sin^2 \theta_{SYSTEM}$$

where  $N$  is the refractive index of the LED encapsulation,  $A_{LED}$  is the LED's emitting surface area,  $\theta_{LED}$  is the half-

angle of the emission cone,  $A_P$  is the active area of the imager panel, and  $\theta_{SYSTEM}$  is the acceptance half-angle of the system.

The acceptance angle of the imager's panel or the F-stop number of the projection lens can limit the acceptance angle of the optical system. As the equation shows, the LED's emitting area is limited to a maximum usable area. If the LED area exceeds this limit, some fraction of light is lost because it cannot be guided through the optical system.

The surface-emitting properties of ThinFilm and ThinGaN LEDs without the use of reflectors provide the highest luminance at the lowest étendue.

You can achieve the best chip size for system efficacy if the LED's étendue equals the system étendue, as the following equation shows:

$$A_{LED} = (A_P \sin^2 \theta_{SYSTEM}) / (N^2 \sin^2 \theta_{LED})$$

The half-angle,  $\theta_{LED}$ , of the emission cone of a surface-emitting LED is  $90^\circ$ . A secondary optical system, such as a

lens outside the LED package, is used to collect the light—typically, within a  $70^\circ$  or smaller cone. Therefore, the collection angle influences the optimum chip size. A narrower collection angle allows a larger usable chip area (Reference 3).

As costs increase with imager size, you should try to use the smallest imager that meets the performance requirements. Because the LED's cost also increases proportionally with the chip area, the goal is to maximize the chip area for chip efficacy but not to exceed the system étendue limit; doing so would waste the excess chip area.

Several small DMD and LCOS imager panels are available for embedded systems. Table 1 lists the parameters of four imager panels and the optimum LED chip size.

### ILLUMINATION TYPES

The four-chip LED products containing RGGB (red/green/green/blue) are typically for one-channel illumination (Figure 4). The two green chips help to

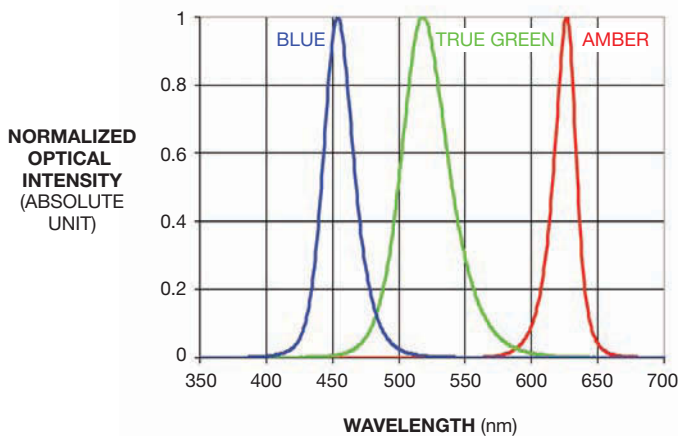


Figure 2 Dominant wavelengths of 617, 525, and 460 nm project the spectral emission for red, green, and blue, respectively.

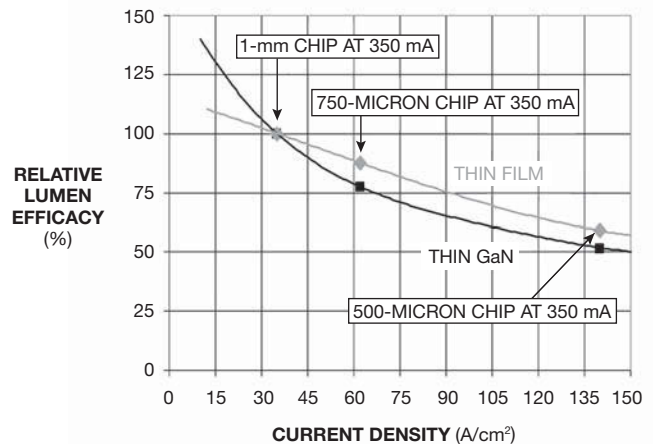


Figure 3 The relative efficacy, normalized to 100% at 350 mA/mm<sup>2</sup>, for ThinFilm and ThinGaN chips, decreases with increasing current density at 350 mA for the standard chip sizes: 500 microns, 750 microns, and 1 mm, or 20, 30, and 40 mil.

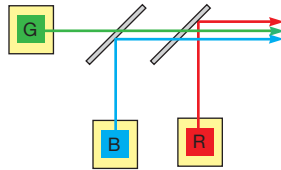
TABLE 1 IMAGER PANELS AND LED SIZE

	HD DMD	WVGA DMD	WVGA LCOS	720p LCOS
Diagonal size (in.)	0.22	0.3	0.21	0.28
F-stop number	2.4	2.4	1.8	1.8
Acceptance angle (°)	12	12	16	16
Étendue (mm <sup>2</sup> )	1.74	3.24	2.74	4.86
Optimum chip size (mm)	1.1×0.62	1.5×0.84	1.37×0.77	1.83×1.03

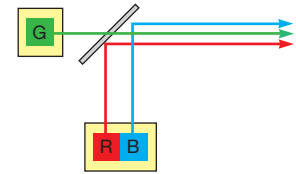




**Figure 4** The four-chip LED products containing RGGB (red/green/green/blue) are typically for one-channel illumination.



**Figure 5** The most straightforward illumination architecture is a three-channel configuration in which dichroic filters combine the three beams of colors.



**Figure 6** Combining red and blue in one device and green in a separate package is the basis for a two-channel configuration.

compensate for the lower efficiency of the green LED; green contributes more than 65% of the white-screen lumens. Although the one-channel approach eliminates the need for combining color beams, an optics element, such as a lens array or a mixing rod, is necessary for achieving color uniformity across the whole imager panel (Reference 4). The screen lumens are limited because the maximum emitting area contains all three colors. Therefore, designers use this approach mainly for low brightness and low cost due to component simplicity (Reference 5).

The most straightforward illumination architecture is a three-channel configuration in which dichroic filters combine the three beams of colors (Figure 5). This approach can use the maximum emitting area for each color because it superimposes the three areas. Three-channel illumination offers the highest system throughput but costs more and requires more space due to the need for additional hardware.

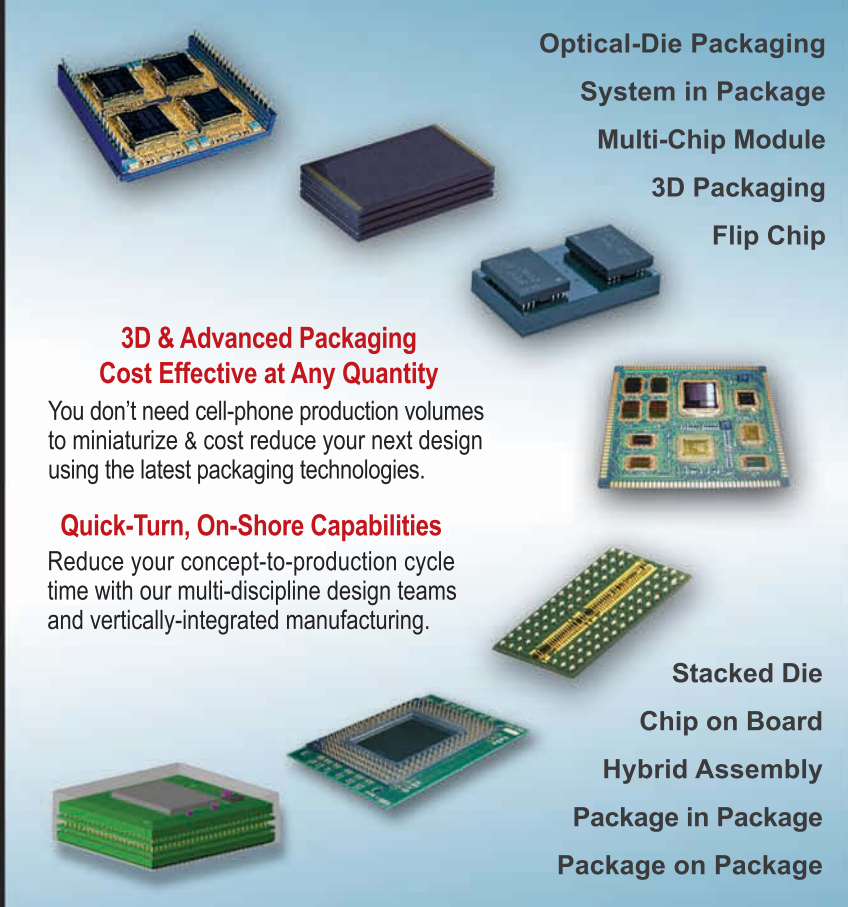
Combining two colors within one LED device and using a second device for the remaining color is the basis for a two-channel configuration. This approach takes up less space and costs less than a three-channel approach and offers higher throughput than a one-channel approach.

Figure 6 shows the configuration of green and red/blue, combining red and blue in one device, with green in a separate package. It is usually beneficial to use a 1- or 2-mm<sup>2</sup> chip for green, which is larger than that for the red/blue chip, to compensate for the lower efficiency of the green LED.

### CONVERTED GREEN

Due to the need for more than 65% of the green flux component to generate white light, Osram has developed

## Be As Small As You Can Be



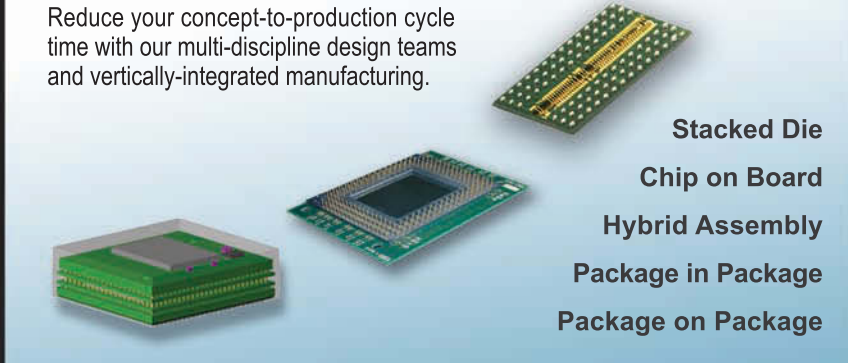
**Optical-Die Packaging**  
**System in Package**  
**Multi-Chip Module**  
**3D Packaging**  
**Flip Chip**

**3D & Advanced Packaging**  
**Cost Effective at Any Quantity**


You don't need cell-phone production volumes to miniaturize & cost reduce your next design using the latest packaging technologies.

**Quick-Turn, On-Shore Capabilities**

Reduce your concept-to-production cycle time with our multi-discipline design teams and vertically-integrated manufacturing.



**Stacked Die**  
**Chip on Board**  
**Hybrid Assembly**  
**Package in Package**  
**Package on Package**



**Interconnect Systems, Inc.**

Designed and Manufactured in the U.S.A.  
[www.isipkg.com](http://www.isipkg.com) 805.482.2870 info@isipkg.com

converted green by using a blue-LED pump to excite green-ceramic-based phosphor. This combination results in 90% more green lumens with wider spectrum than native true green (Figure 7). The built-in dichroics in a two- or three-channel architecture remove the overlapping color spectrum, resulting in

approximately 40% higher white-lumen output (Figure 8).

### DRIVE ELECTRONICS

Using a multichannel single-driver chip yields cost and space savings. In a color-sequential system, generally only one color is turned on at any time. For this

reason, some drivers can effect additional savings with the use of shared circuitry for the three colors.

However, it is important to make two allowances in the selection of the LED driver. First, make sure that the chip can accommodate the difference in forward voltage between the red

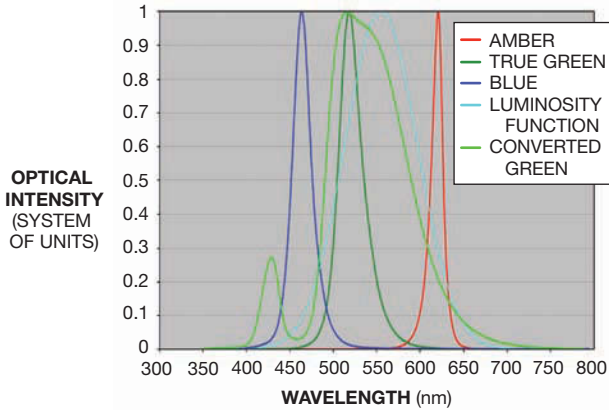


Figure 7 Converted green uses a blue-LED pump to excite green-ceramic-based phosphor. This combination results in 90% more green lumens with wider spectrum than native true green.

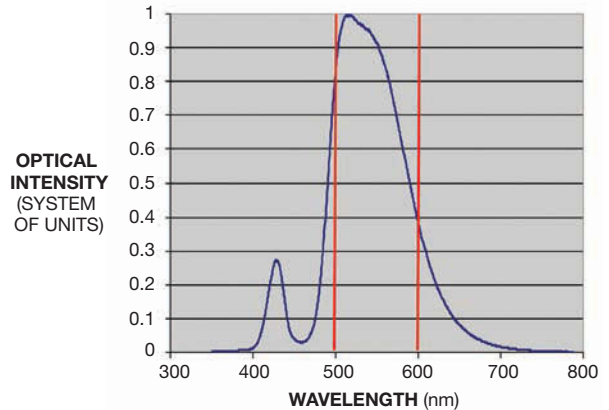
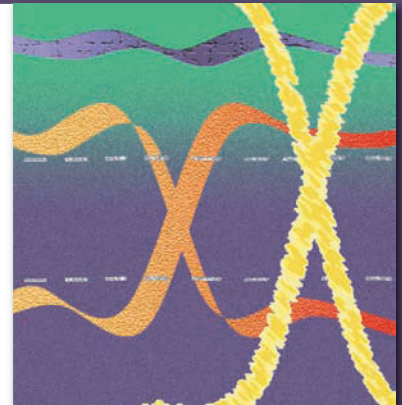


Figure 8 The built-in dichroics in a two- or three-channel architecture remove the overlapping color spectrum, resulting in approximately 40% higher white-lumen output.

Circuits Layout SSO Ringing Probes Power Crosstalk Grounding  
EMC Noise Jitter RLGC Thermal Stripline Routing



Signal Integrity —  
Dr. Howard Johnson  
and his



extraordinary *Black Magic* seminars...

Ottawa, ON

4-5 June

High-Speed Digital Design

6-7 June

High-Speed Noise and Grounding

Toronto, ON

11-12 June

Adv. High-Speed Signal Propagation

Oxford University, UK

26-27 June

High-Speed Digital Design

28-29 June

High-Speed Noise and Grounding

[www.sigcon.com](http://www.sigcon.com)

Use promo code: EDN12

For serious digital designers.



chip—typically, 2.5V—and that of the blue and green chips—typically, 3.6V. Second, overlapping two or more colors can increase projector output in some projector designs.

LEDs are excellent light sources for pico projection due to their compact size and high lumen output. The selection of an optimal LED for projector efficacy takes into account system size, imager type and size, brightness requirements, and power consumption. The use of different chip and package sizes enables illumination architectures, such as one-, two-, and three-channel illumination, depending again on the same factors as in LED selection.

You can achieve optical efficiency of more than 90% for three-channel architectures and more than 80% for two-channel architectures with the appropriate choice of LED and imager. In addition to the efficacy, projector engine size and cost are also key variables when selecting an LED for pico projection.

Dell recently launched the M110 ultramobile projector, which outputs 300 lumens using a three-channel architecture and converted green. Assuming that LEDs follow Moore's Law, you can expect further gains in brightness and lower cost in the coming years. Projectors embedded in cell phones will be more common, and pico projectors will be bright enough for serious business presentations without the need to dim room lighting. **EDN**

## REFERENCES

- 1 Coggshall, William, "Pico/Pocket Projection Opportunities," Projection Summit Proceedings, 2008.
- 2 Fournier, F, and J Rolland, "Design Methodology for High Brightness Projectors," *Journal of Display Technology*, March 2008, pg 86, <http://bit.ly/GDzBe9>.
- 3 Pate, M, "Digital Projector Technology," *Optical Short Course International*, 2005, <http://bit.ly/GDV8bO>.
- 4 Phillips, B; J Grace; Z Yun; S Willett; D Snively; T Pol; B Ardashnikov; G O'Shea; J Moskovich; and MH Kreitzer, "A high efficiency mobile projection engine utilizing color sequential illumination," *SID Symposium Digest*, 2009, pg 178.
- 5 Darmon, D; JR McNeil; and MA Handschy, "LED-illuminated Pico Projector Architectures," *SID Symposium Digest*, 2008, pg 1070.

## AUTHORS' BIOGRAPHIES



Francis Nguyen is a senior product manager at Osram Opto Semiconductors (Sunnyvale, CA), where he is responsible for marketing LED products for use in LED displays, LCD backlighting, and projection displays. Nguyen has had various engineering and product-management positions. He holds a bachelor's degree in electrical engineering from the University of Hong Kong.



Stefan Morgott studied physics at the University of Ulm (Ulm, Germany), where he presented a doctoral thesis in electrical engineering at the Fraunhofer Institute for Applied Solid State Physics. He has been at Osram Opto Semiconductors since 2000, focusing on optical-semiconductor amplifiers. Previously, he was a testing and application engineer for infrared laser diodes and an application engineer for visible LEDs.

# THINK

CATALOG M60



It's what's on the inside  
that counts.

Discover More Than 1,000 New Products.  
SMT and THM Interconnect Components  
and Electronic Hardware.

YOU NEED IT? WE HAVE IT!

RoHS Compliant ~ ISO 9001 Certified

**KEYSTONE**  
ELECTRONICS CORP.



# CONTROLLER ICs TAKE MULTITOUCH SCREENS BEYOND SMARTPHONES

AS MULTITOUCH TOUCHSCREENS MOVE BEYOND SMARTPHONES AND TABLETS INTO **AUTOMOTIVE, MEDICAL, AND INSTRUMENTATION APPLICATIONS**, THEIR FEATURES EVOLVE TO FIT LOWER PRICES AND VARYING FORM FACTORS.

BY MARGERY CONNER • SENIOR TECHNICAL EDITOR

Since *EDN* last surveyed touchscreens (Reference 1), they have become firmly entrenched in smartphones and are making their way into the lower-cost “feature phones” from vendors eager to attain some of the cachet of more expensive phones. Tablets such as the iPad and, more recently, the Kindle Fire also are helping to make touchscreens commonplace. As users become familiar with interactive, infinitely changeable touchscreens in their consumer electronics, they expect the same level of interactivity in other non-traditional uses for touchscreens, such as automobiles, medical electronics, and industrial devices.

IMAGE: THINKSTOCK



D





Touchscreens have been around for decades, and they typically employ resistive-touchscreen technology. With resistive touchscreens, a user's finger physically deforms the top layer of the screen, causing the resistive sensor to make contact below the finger. The resistive sensors are in a grid of X and Y traces, separated by a thin, transparent insulator.

Note the use of the word “press.” A press is a different action from a touch or a swipe. Resistive touchscreens have limited capabilities in their response to multitouch gestures, such as pinches, zooms, swipes, and scrolls. Users who have become accustomed to navigating their smartphones and tablets with these gestures become frustrated with simple touchscreens that lack these features. Touchscreens that can respond to complex multitouch gestures generally rely on capacitive sensing.

Capacitive-sense-touchscreen technology generally comes in self-capacitance and mutual-capacitance flavors, although other types, such as projected capacitance, exist. Self-capacitance sensors comprise a series of thin lines of indium-titanium oxide, a transparent, conductive material in an XY grid with an insulating layer between the X and the Y traces. Touching an area in the grid changes the parasitic capacitance of the sensors to ground. However, this approach can't handle multiple-finger

### AT A GLANCE

Users now expect touchscreens in applications beyond high-end smartphones and tablets, and they are beginning to show up in cars and instrumentation.

Cost is a constraining factor in the use of touchscreens as capacitive screens vie with less expensive and less responsive resistive technology.

In an attempt to mimic the sensory environment of the real world, haptics technology is dropping in price and may make its first inroad through the game market.

touches because the sensor can't distinguish between multiple fingers along the same grid line. Mutual capacitance senses the change in the capacitor at the small intersection of the X and the Y lines. Because the area of the intersection is small, the capacitance is also small, but it is precise and can measure multiple-finger placements.

There are pros and cons to each approach. Although self-capacitance sensors generally cannot distinguish between multiple simultaneous finger actions, they also generate a stronger electromagnetic field that can detect objects even if the objects don't actually touch the screen. Mutual-capacitance touch-

screens can detect and track the touch of multiple fingers, but the fingers must touch the screen because the electromagnetic field from the tiny capacitors formed by the intersection of the two sensors is so small.

The need for close contact between the finger and the touchscreen can be a problem when the user is wearing gloves. This restriction on the part of capacitive touchscreens causes a shift in favor of resistive screens. Resistive technology also has an advantage in liquid applications or in humid climates in which moisture affects the behavior of the electromagnetic field. Cypress' TrueTouch controller technology seeks to overcome these hurdles by combining both self- and mutual-capacitance techniques (Reference 2).

Both self-capacitance and mutual capacitance require the same XY sensor grid. In self-capacitance, the controller must drive both the X and the Y lines. In mutual capacitance, the controller transmits into the X lines and receives on the Y lines. Because the TrueTouch controller IC uses Cypress' PSoC (programmable-system-on-chip) core, the controller can dynamically configure its I/O pins and turn the transmitters into receivers on the fly. Thus, the controller can sense in both modes—self- and mutual capacitance—whenever the controller scans the sensor's grid panel. Combining self-capacitance sensing

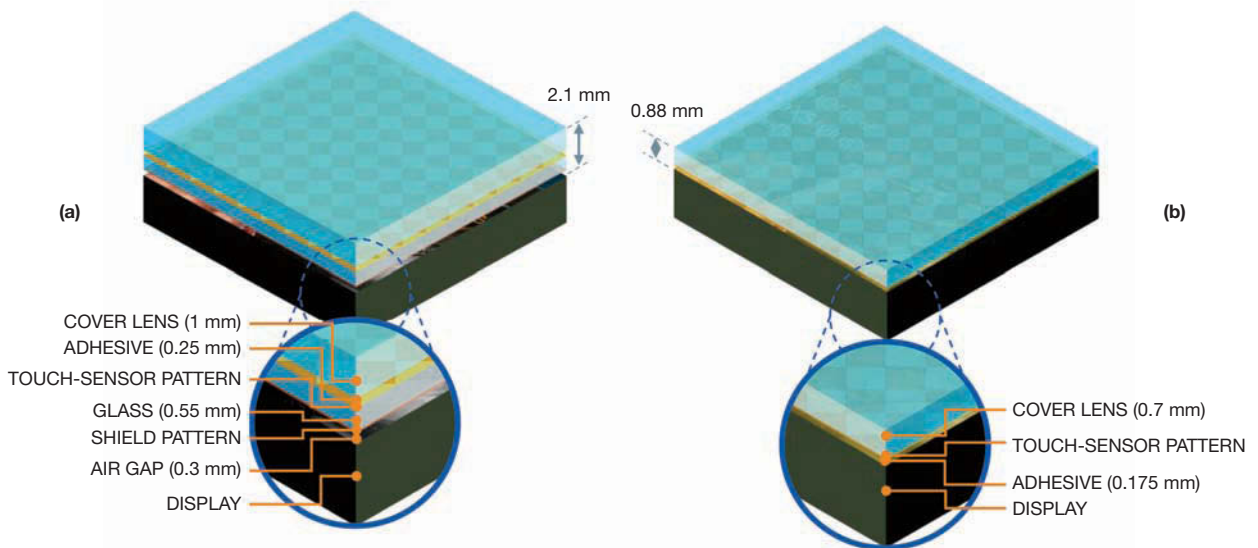


Figure 1 The touchscreen stack has an ITO shield (a). The lack of such a shield means fewer layers to reduce thickness and increase display brightness but can make for LCD-noise problems (b).

# Is your scope lying to you?

## Find out.

# Rohde-Schwarz-scopes.com

If you're not using a new Rohde & Schwarz digital oscilloscope, your scope may not be giving you honest answers.



Try the industry's most accurate and reliable digital oscilloscope.



888-837-8772

[www.rohde-schwarz-scopes.com](http://www.rohde-schwarz-scopes.com)



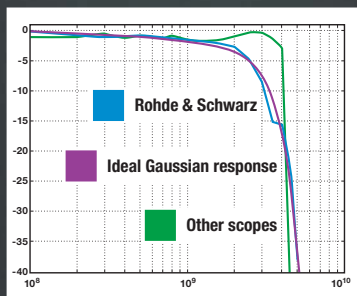
**ROHDE & SCHWARZ**



# Scope Lie #1

## Your digital scope's bandwidth

When it comes to small signal bandwidth, engineers need a gradual signal roll-off to avoid seeing a lot of ringing and overshoot in the time domain.



Today's digital scopes employ very sharp, high-order frequency responses that trade minimum sampling rates for maximum bandwidth. The result is high overshoot and ringing when measuring typical digital signals.

Try the scope that tells the truth by utilizing slow roll off to eliminate overshoot and ringing.

Discover how your digital scope may be misrepresenting results at

[www.rohde-schwarz-scopes.com](http://www.rohde-schwarz-scopes.com)

888-837-8772



with mutual capacitance allows for multitouch capability even with hands wearing thick ski gloves. This ability raises the question of how safe touchscreens in automobiles are (see sidebar "Q&A on auto safety and touchscreens with JD Power").

Touchscreens in cars, at 10 in. or more diagonally, are usually larger than smartphone touchscreens, which are typically about 4 in. Atmel's MaxTouch line of touchscreen controllers includes the mXT768E and mXT540E automotive-qualified controllers for 5- to 10-in. touchscreens in center-stack displays, navigation systems, and back-seat entertainment systems. Conventional controllers for capacitive touchscreens require a shield layer within the multi-layer touchscreen to prevent noise coupling from the LCD. Atmel claims that

the MaxTouch devices offer a signal-to-noise ratio of 80-to-1, eliminating the need for a shield layer and enabling a single-layer sensor design for lower-cost, thinner stacks (Figure 1). A high SNR also enables detection of touches from a finger in a thin glove. In general, the technology can sense touch from gloves as thick as 1.5 mm, such as leather, wool, or cotton gloves.

An elegant-looking touchscreen design imparts a cool factor that is nearly as important to consumers as the touchscreen's performance, and industrial design decrees that, for smartphones, thinner is always better. Cypress' SLIM (single-layer-independent-multitouch) technology makes for a thinner screen because the sensor is one layer rather than two. For conventional two-layer stackups, manufacturers build the sen-

## Q&A ON AUTO SAFETY AND TOUCHSCREENS WITH JD POWER

**C**omments on a recent blog post on new touchscreen-controller products raised questions about how safe touchscreens are in vehicles, in which drivers should keep their eyes on the road (Reference A). Mike VanNieuwkuyk, executive director for global automotive research at market researcher JD Power and Associates, recently answered the following questions for EDN.

**Touchscreens seem to require that drivers look at them during use because they lack the built-in "feel" of knobs and pushbuttons. Does this lack make them more hazardous than dedicated hardware interfaces?**

**A** Certainly, any technology that removes the driver's attention from the road introduces some level of driver distraction. The position of the screen, screen size, icon/screen buttons, text size, [and the like] all affect the effectiveness of a touchscreen. However, there are also features that can be integrated with the use of a touchscreen that provide the driver with feedback to ensure that the proper/positive execution of a control is achieved. The feedback can be in the form of an audible response, such as a tone, click, [or] confirming voice; a visual response, such as a light indicating active/on; or a tactile response via actuators that provide a vibration [or] thump. These feature characteristics can be tied into the use of a touchscreen to confirm to the consumer that the intended control was used and the desired result was achieved.

**Touchscreens are infinitely variable; interface designers have almost no limits on the size, number, and performance of screen functions. Is there a steep learning curve for drivers using touchscreens, such as those on the MyFord Touch [Reference B]?**

**A** With any new technology, there is a learning curve. Touchscreens do offer great flexibility and creativity. The possibilities for the use of touchscreens will come with some difficulty until the consumer becomes familiar with the interface. Many consumers are being exposed to touchscreen devices outside the automobile, which creates greater acceptance and high expectations. However, touchscreen use outside the automobile is highly interactive; within a vehicle, it cannot be at the same level.

**Do touchscreens work reliably with gloved fingers?**

**A** The use of touchscreens with gloves can introduce issues regarding actuation and positive response. Traditional touchscreens cannot sense



sors on two layers: the X lines and the Y lines in separate layers with an insulator between them. This XY grid is expensive because of the cost of ITO, which is effectively a transparent metal and costs about \$1 per diagonal inch of screen.

Cypress has created a proprietary pattern that allows the routing of both the X and the Y sensors on the same surface in one layer with no jumpers or vias (Figure 2). John Carey, director of marketing for TrueTouch controllers at Cypress, claims that SLIM makes for the thinnest and lowest-cost touchscreen sensor and works for screens as large as 4.5 in. diagonally. The company does not reveal what the pattern is; customers work with Cypress' licensed-partner touchscreen suppliers.

Even with the decrease in prices for multitouch touchscreens, they are still

about 10 times more expensive than resistive screens, which have a large installed base. For applications in which cost is dominant yet that still require some form of multitouch, Freescale offers the Xtrinsic CRTouch, which enables the retrofitting of resistive touchscreens to recognize slides, two-finger pinches for zooming in and out, and multifinger rotations on standard resistive touchscreens. The chip uses proprietary algorithms and dedicated analog hardware, as well as on-chip state machines. The controller chip also manages as many as four capacitive touchpads for realizing keypads, rotary dials, and linear sliders. As a part of Freescale's Ready Play offerings, the CRTouch chip offers turnkey software integration with both Android and Linux operating systems. The chip also offers configurable screen resolution

control [with a user with] a glove on [because the touchscreen] needs contact with skin. There are specialized gloves that the consumer could wear, but expecting consumers to purchase and wear these gloves is unrealistic. [Some new] touchscreens use an electronic field above the surface, which, when the field is broken, the areas ... would actuate the intended control. This [action] can be done [by a user] with gloves. However, the additional issue of gloved-hand use is that the glove increases the size of the finger and could introduce unintended use if the control layout on the touchscreen is too small.

**Where do you see touchscreens going in the automotive market? Will they become a must-have or a nice-to-have feature over the next five years? Alternatively, will some hybrid of touchscreens and dedicated screens emerge?**

**A** There are compelling reasons to use touchscreens in multiple areas of the vehicle. The flexibility and personalization opportunities are appealing to automotive consumers, given the time spent in vehicles and consumers' desire to make this time useful, comfortable, connected, and entertaining. There are always challenges to the placement of screens, both dedicated and touch, in a vehicle. Issues with interaction, sight lines, reach zones, and glare will determine when a touchscreen

versus a dedicated screen is the better alternative. The likely outcome is that we will see a hybrid of screen types, along with traditional buttons and knobs for functions [in which] familiarity enhances use and minimizes distraction. Also, the integration of improved voice recognition as part of the entire control set will surely influence how and where screens will be used.

## REFERENCES

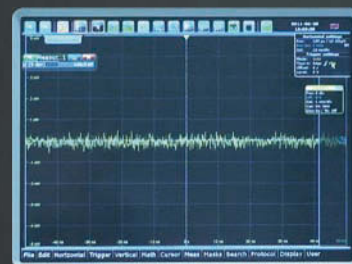
- A** Conner, Margery, "Single-layer touchscreens gain new controller, ITO sensor," *EDN*, April 5, 2012, pg 18, <http://bit.ly/ljQHTk>.
- B** O'Donnell, Jayne, "Some Ford owners to get touch-screen software fix soon," *USA Today*, Feb 8, 2012, <http://usat.ly/GG7Ze6>.



# Scope Lie #2

## Your digital scope's noise specification

Today's digital scopes only provide a 5 or 10mV/division setting and use a digital zoom to "get down to" a 1mV/division setting. This tactic significantly increases noise while lowering the accuracy. As a way to reduce the noise, some oscilloscopes limit bandwidth on low volts per division settings, while others do not offer the 1mV/division setting at all.



Try the scope that has a true, low noise performance and highly accurate 1mV/division setting.

Discover how your digital scope may be misrepresenting results at

[www.rohde-schwarz-scopes.com](http://www.rohde-schwarz-scopes.com)

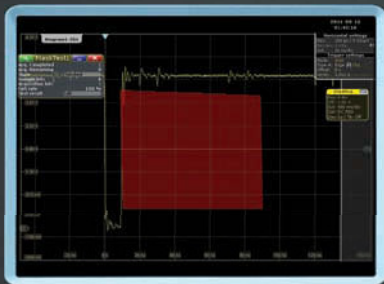
888-837-8772

**ROHDE & SCHWARZ**

# Scope Lie #3

## Your digital scope's update rate

Digital scope manufacturers boast update rates of 1+ million waveforms/sec, but this spec excludes measurements and mask testing. These demanding scope measurement tests slow down the update rate of most digital oscilloscopes. When conducting a mask test at lower update rates, finding an event that occurs once per second could take anywhere from minutes to hours.



Try the scope that maintains extremely high waveform update rates while performing a mask test, and locates the error in less than 30 seconds.

Discover how your digital scope may be misrepresenting results at

[www.rohde-schwarz-scopes.com](http://www.rohde-schwarz-scopes.com)

888-837-8772

 **ROHDE & SCHWARZ**



**Figure 2** Cypress' SLIM technology uses a proprietary pattern that allows designers to route both the X and the Y sensor grid lines on the same surface in one layer with no jumpers or vias.

and optional calibration and pressure detection for stylus inputs to resistive touchscreens.

Partially to reduce costs, Amazon used infrared touch sensors on the Kindle Touch. The Touch reader has a black-and-white e-ink display that benefits from the lack of an ITO layer between it and the viewer. The screen instead

relies on infrared sensors in the bezel that detect when a finger breaks the IR beam. The display can respond to multitouch pinching motions, which it uses to cue zoom or shrink on PDFs, but is incapable of the more elaborate multitouch gestures of smartphones (**Reference 3**).

As touchscreens move into applications such as automobiles, instru-

## HAPTICS 101

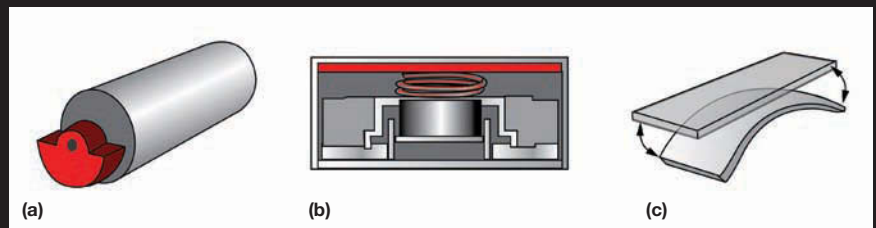
By Eric Siegel, Texas Instruments

Let's face it: We are a voyeuristic society, and screens are everywhere. As demand for more and more features has increased, we've seen common viewing screens become portals of interaction, now equipped with touch detection. Although touch capability comes in many flavors, including resistive, capacitive, and optical, the next evolution is allowing these touchscreens to touch back, which is exactly what haptics allows them to do. Haptics is the ability to deliver vibrational, or tactile, feedback through a device or screen (**Figure A**).

Haptic feedback also comes in many flavors, with three main imple-

mentations: ERMs (eccentric rotating masses), LRAs (linear resonant actuators), and piezoelectric actuators. ERMs and LRAs are inertial-based actuators that involve moving a mass in a linear motion to create the detected vibration force. ERMs use an off-center weight, and LRAs use a spring-oscillated mass. ERMs offer a cost-effective approach for delivering basic haptic effects but consume a significant amount of power and take 50 to 80 msec to deliver an effect, which is slower than their counterparts (**Reference A**).

LRAs offer great power savings when they are run at their resonant



**Figure A** Haptics displays rely on actuators to give a touchscreen the ability to touch back. The main types of actuators in haptics are eccentric rotating masses (a), linear resonant actuators (b), and piezoelectric actuators (c).



**Figure 3** The SmithsonianMartin Emulator DVS DJ System is a transparent mixing desk that allows the audience to see the DJ through the mixing panel. Cameras in the corners can track finger movement, enabling the display.

mentation, and medical devices, these devices' user interfaces can become infinitely adjustable and updatable. The placement of physical control knobs and dials has always been important for test-and-measurement-equipment

designers, with focus groups spending inordinate amounts of time deciding which button should go where.

A catchphrase for spectrum-analyzer designers in the past was "tune, boom, zoom," in which tune was the center frequency; boom was the reference level, or amplitude; and zoom was the span of the signal under measurement. The equipment designer's goal was to make tune, boom, and zoom as fast and as accessible as possible. For example, burying the center frequency, the reference level, and the span buttons in

some menu structure would be a bad idea. Instead, those three buttons are usually fairly prominent on a spectrum analyzer's front panel. Loyal customers are often reluctant to accept front-panel changes. Now, equipment designers can

frequency. Due to their spring-mounted assembly, however, the spring constant of the system can change through a variety of internal and external variables. This problem may seem insignificant. If the system doesn't operate at the resonant frequency, however, the system cannot achieve the maximum efficiency of power and maximum strength of acceleration.

Piezoelectric actuation is a relatively new method of haptic feedback. It leverages the principles of piezoelectricity in ceramic materials, in which there is a relationship to voltages within an object and their current shape. However, instead of bending a device to find a change in voltage, the opposite occurs. An applied voltage causes a change in the natural state of the actuator.

Piezoelectric actuation offers more robust performance than the other two technologies. It is the only haptic technique in which you can initialize localized haptics—that is, when only one area of a device feels the haptic effect. In whole-body haptics, on the other hand, the entire device feels the effect. Think about being able to feel an effect under only one finger versus feeling an entire device

shake in your pocket. Piezoelectric haptics can enable that effect. It also features more options for effects and a response time of less than 1 msec, which means that you can execute 30 to 80 effects in the time it takes you to execute one with an ERM. The bandwidth of piezoelectric actuation is also better than that of its inertial counterparts, and, therefore, it can seamlessly re-create the feeling of pressing a mechanical button.

Haptic effects' added value to a device are well worth their price when you compare them with the minor cost to the system—especially when many of the key target markets already use the components. Haptics is a great way to increase user satisfaction, showcase product differentiation, and further bridge the gap between human and machine interaction.

#### REFERENCE

▲ "What is Haptics? A Q&A with TI's Haptics Team," Texas Instruments, July 14, 2011, <http://bit.ly/GHIFUP>.

#### AUTHOR'S BIOGRAPHY

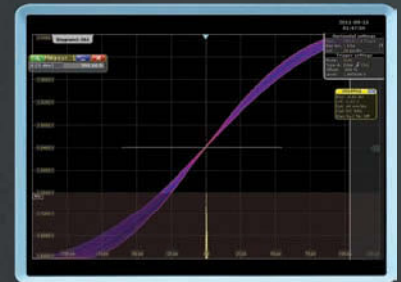
*Eric Siegel is a product-marketing engineer for touchscreen controllers and haptic devices at Texas Instruments.*

# Scope Lie #4

## Your digital scope's analog trigger

Most analog and digital scopes utilize separate circuits for trigger and waveform acquisition. These circuits have different bandwidths, varying sensitivities and diverse characteristics which can cause trigger jitter.

The R&S®RTO digital oscilloscope does not split the captured signal into a trigger circuit and acquisition circuit, virtually eliminating trigger jitter and enabling you to trigger on any specified trigger point.



Try the scope with the digital trigger, that triggers on the same waveform you see on the screen.

Discover how your digital scope may be misrepresenting results at

[www.rohde-schwarz-scopes.com](http://www.rohde-schwarz-scopes.com)

888-837-8772





# DesignNews



## CONTINUING EDUCATION CENTER

# Get current, without the hassle.


With Digi-Key's Continuing Education Center, catch up to 180 days of free, interactive courses engineered by Design News, starting January 2012. Build your engineering know how. Take one or all. It's your choice.

Tracks include: Microcontrollers Basic, Microcontrollers Advanced, MEMS Sensor Technology, Lighting, Embedded Internet and Cloud, Wireless, and Power.

**REGISTER AT**  
[DesignNews.com/dkcec](http://DesignNews.com/dkcec)

**FOLLOW US**

@DigiKeyCEC 

Digi-Key Continuing Education Center 



  
**UBM**  
Electronics

allow customers to customize the control panel to suit their own preferences.

In an attempt to mimic the sensory environment of the real world, haptics technology is also dropping in price and may make its first inroad through the game market. Sensory feedback from the touchscreen can make for a richer experience in gaming; in automotive or instrumentation touchscreens, it can free the operator from watching the touchscreen for a visual cue that the system has noted and reacted to an action (see sidebar "Haptics 101").

Looking to the future, much larger control surfaces than touchscreens will soon enter the market. Self- and mutual-capacitance sensing becomes less practical with screens larger than 10 in., yet some devices need the physical impact of a larger surface. For example, the Smithsonian's Emulator DVS DJ System is a transparent mixing desk that allows the audience to see the DJ through the mixing panel (Figure 3). The transparent screen has a projector below it, which displays the buttons, knobs, and sliders that the DJ sees through the screen. The audience can also see the DJ through the transparent screen. Cameras in the corners can track finger movement, enabling the touchscreen. **EDN**

#### ACKNOWLEDGMENT

Thanks to Justin Magers of National Instruments for his explanation of "tune, boom, zoom" and its place in instrument design.

#### REFERENCES

**1** Dipert, Brian, "A magic touch: The concept's sound, but implementation options abound," *EDN*, Nov 4, 2010, pg 26, <http://bit.ly/dxyLuQ>.

**2** Conner, Margery, "Single-layer touchscreens gain new controller, ITO sensor," *EDN*, April 5, 2012, pg 18, <http://bit.ly/ljQHTk>.

**3** Heater, Brian, "Amazon Kindle Touch Review," *Engadget*, Nov 14, 2011, <http://engt.co/GGH296>.



[[www.edn.com](http://www.edn.com)]

# Embedding Wireless Just Got a Whole Lot Easier



*And Faster, and Smaller,  
and Less Expensive . . .*

- 2.4GHz Frequency Hopping Spread Spectrum Performance

- FCC, Canadian IC and ETSI Pre-Certified

- RF Data Rate of 250 kb/s

- Multiple analog, digital, UART and SPI interfaces

- Battery operation supporting sleep mode and Auto-Reporting

- No programming or co-processor needed

- U.FL and Chip Antenna versions available

- Developer Kits Available

**. . . YET PACKING  
MORE RELIABILITY  
AND FEATURES**



**DNT24**  
**\$29**  
Qty of 1

<http://www.rfm.com/>

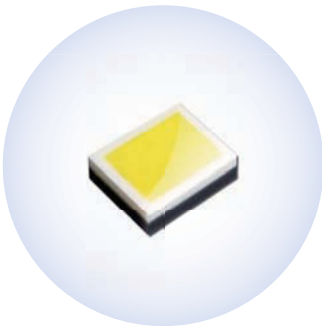


**Click here to find out  
how RFM's pre-certified**

modules can deliver reliable wireless for your **residential, commercial, industrial, and agricultural** applications in a fraction of the time, at a fraction of the cost, and with a fraction of the hassle.

#### Where to Buy:

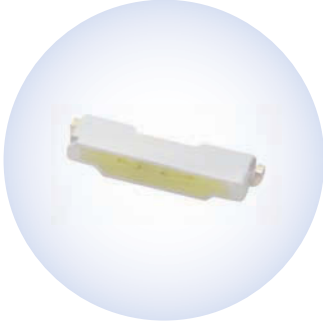
- Avnet Memec
- Digi-Key
- Future Electronics
- Mouser Electronics



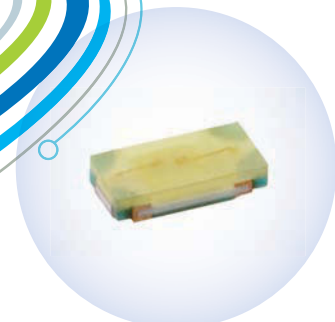
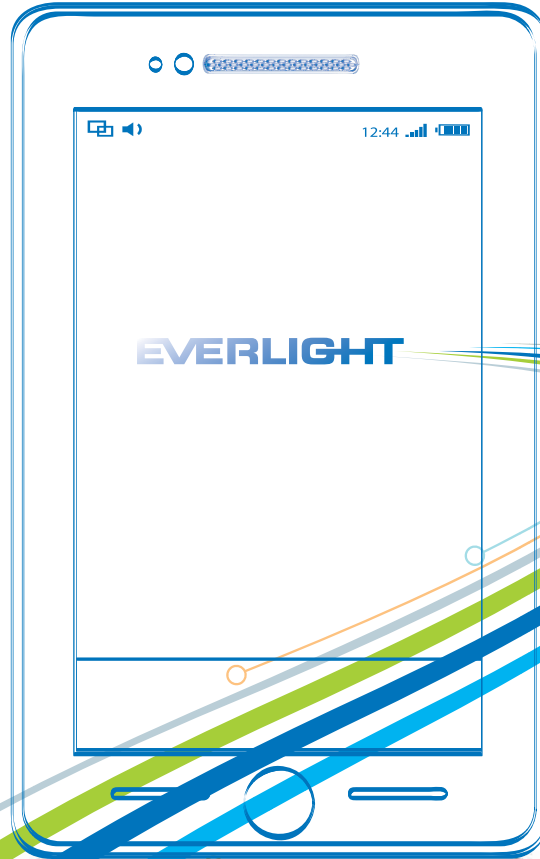
Flash LED



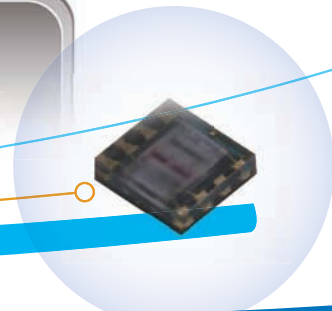
Ambient Sensor



TFT Backlighting



SMD LED Indicator



Infrared LED

## The Right Component for the Right Application

EVERLIGHT Electronics provides numerous opto-Electronic components for smartphone. With comprehensive product portfolios, EVERLIGHT is able to offer a total solution in order to fulfill all demands. In the mean time, all EVERLIGHT products are RoHS Compliant, contributing to a sustainable and environmental-friendly lifestyle around the world.

[www.everlight.com](http://www.everlight.com)

# EVERLIGHT



## THE NUANCES OF **VARIABLE-FREQUENCY DRIVES**

BY STEVE TARANOVICH •  
SENIOR TECHNICAL EDITOR

Get an inside view of induction-motor control by varying frequency using PWM.

**Y**ou can divide the world of electronic motor drives, which control the speed, torque, direction, and resulting horsepower of a motor, into two categories: ac and dc. An ac drive controls ac induction motors and, like its dc counterparts, controls speed, torque, and horsepower. A dc drive typically controls a shunt-wound dc motor, which has separate armature and field circuits. This teardown of the Schneider Electric Altivar 12 variable-frequency drive details the key features that define these drives.



Rotating equipment, including fans, blowers, compressors, and pumps, consumes more than one-third the total electrical energy generated in the United States. This equipment may use variable-speed-drive technology, in which motor speed adjusts to meet the load requirements, yielding an advantage in both improved productivity and reduced energy consumption. For example, lowering fan or pump speed by 15 to 20% enables a decrease in shaft power of as much as 30%.

Properly applied variable-frequency drives are affordable, reliable, and flexible, and they offer a significant amount of savings through reduced electric bills. Electronic variable-frequency drives vary the voltage and frequency to induction motors using pulse-width modulation. The drives use insulated-gate bipolar transistors to convert the fixed-frequency ac supply voltage to a variable-frequency, variable-voltage ac supply to the motor and can regulate the speed of an induction motor from approximately 10 to 200%; wider ranges are possible. The drives also regulate the output voltage in proportion to the output frequency to provide a relatively constant ratio of voltage to frequency to produce adequate torque.

The Altivar 12 manual recommends that you remove the vent covers for IP (ingress protection) Type B and C mounting when IP20 protection is adequate but that you leave them on the housing in Type A mounting (**Figure**

## AT A GLANCE

Variable-speed drives reduce energy costs and prolong equipment life by adjusting motor speed to meet load requirements.

Variable-frequency drives vary the voltage and frequency to an induction motor using pulse-width modulation.

The first step is to convert the ac-supply voltage into dc using a rectifier circuit.

The rectified dc voltage converts back to ac, typically through the use of power electronic devices, such as insulated-gate bipolar transistors.

The output voltage turns on and off at high frequency, controlling the duration of on-time, or pulse width, to approximate a sinusoidal waveform.

1). ANSI/IEC 60529-2004 describes the degrees of protection provided by enclosures. It is a system for classifying the degrees of protection for operators against access to hazardous parts and protection of equipment against the ingress of solid foreign objects and water. Type A mounting allows for free space of more than 50 mm (1.97 in.) on each side, with vent covers in place. Type B mounting allows for side-by-side-mounted drives with removed vent

covers (**Reference 1**). Type C mounting matches that of Type A but with removed vent covers.

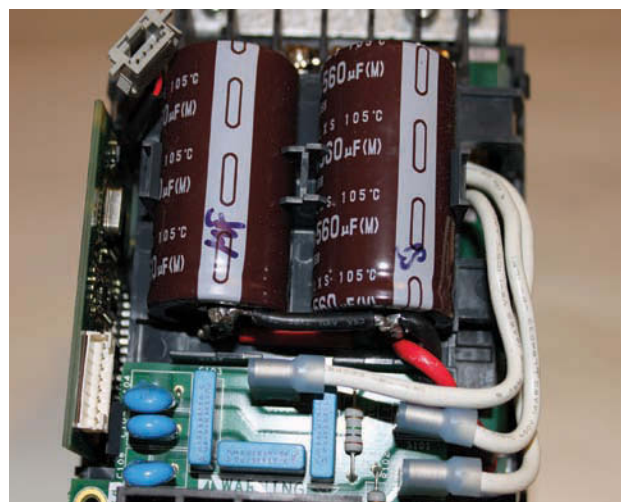
The first step is to convert the ac-supply voltage into dc using a rectifier circuit. The dc power contains voltage ripples, which filter capacitors smooth (**Figure 2**). This dc voltage then converts back into ac, typically using pulse-width modulation (**Figure 3**). The output voltage turns on and off at a high frequency, with the duration of on-time, or pulse width, controlled to approximate a sinusoidal waveform.

The Altivar 12 series uses the Infineon FP30R06W1E3 IGBT module and has a well-designed heat-sink assembly. The Infineon IGBT module uses an Al<sub>2</sub>O<sub>3</sub> substrate, which gives the case a low thermal resistance that is critical to the reliability and long-term performance of the system. Aside from the input converter's diode bridge and output inverter with IGBTs, this Infineon module also has an NTC (negative-temperature-coefficient) thermistor onboard for temperature monitoring of the heat sink and an Easy PIM (personal-information-manager) module (**figures 4, 5, and 6**).

The integrated three-phase gate driver for the IGBT assembly is the Infineon 6ED003L06-F, which features a thin-film silicon-on-insulator technology that makes the six-IGBT-bridge output insensitive to negative transient voltages as high as -50V (**Figure 7**).



**Figure 1** Remove the vent covers for Type B or C mounting when IP20 protection is adequate, but leave them on the housing in Type A mounting.



**Figure 2** The dc link, or dc-bus filter, comprises a series inductor and two filter capacitors in parallel with associated MKP-type capacitors, which are in series with the mains.

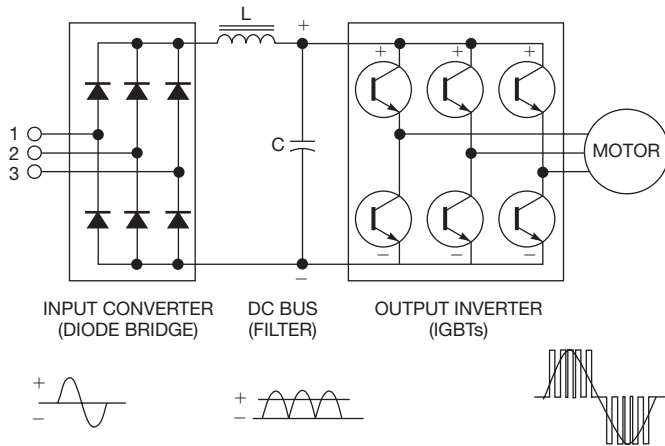


Figure 3 IGBT power transistors can convert the dc voltage back into ac using pulse-width modulation.

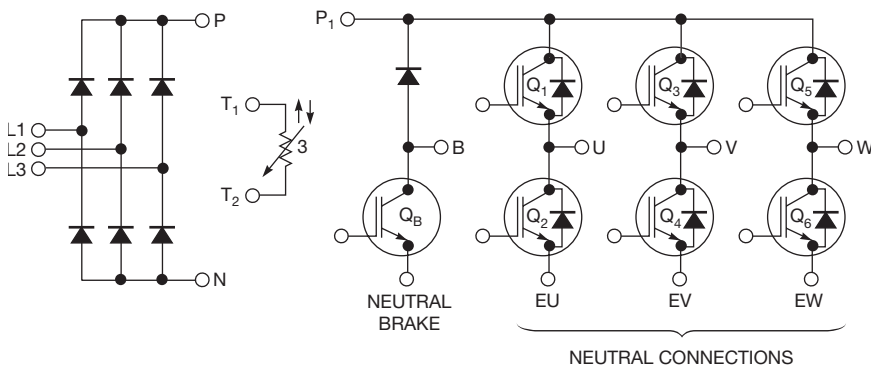


Figure 4 The Infineon FP30R06W1E3 includes rectifier diodes, an NTC thermistor, and IGBTs.

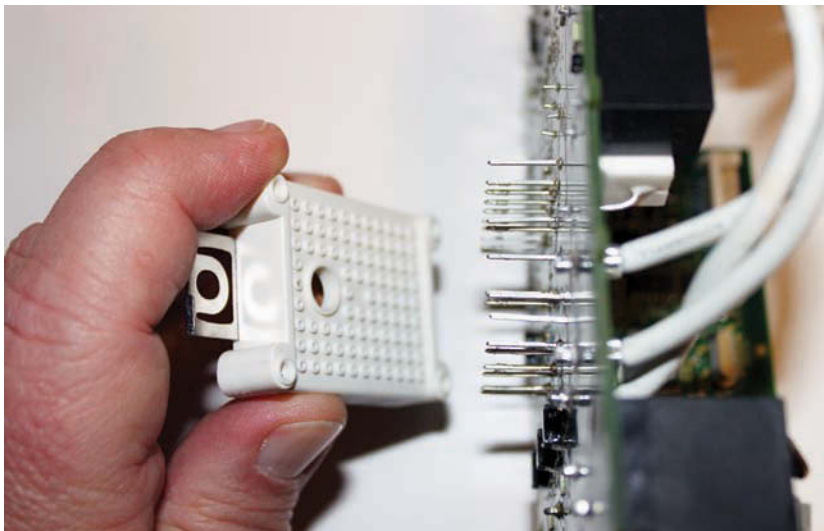


Figure 5 You can easily assemble the Infineon Easy PIM module as a plug-in module on the back of the IGBT-gate-driver card.

# PICO



**DC-DC Converters**  
**2V to 10,000 VDC Output**

- Over 2500 Std. DC-DC Converters
- Surface Mount
- From 2V to 10,000 VDC Output
- 1-300 Watt Modules
- Isolated/Regulated/Programmable Models Available
- Military Upgrades Available
- Custom Models, Consult Factory

Delivery-Stock to one week for sample quantities



for **FREE** PICO Catalog  
 Call toll free **800-431-1064**  
 in NY call **914-738-1400**  
 Fax **914-738-8225**

**PICO Electronics, Inc.**

143 Sparks Ave. Pelham, N.Y. 10803  
 E Mail: [info@picoelectronics.com](mailto:info@picoelectronics.com)  
[www.picoelectronics.com](http://www.picoelectronics.com)





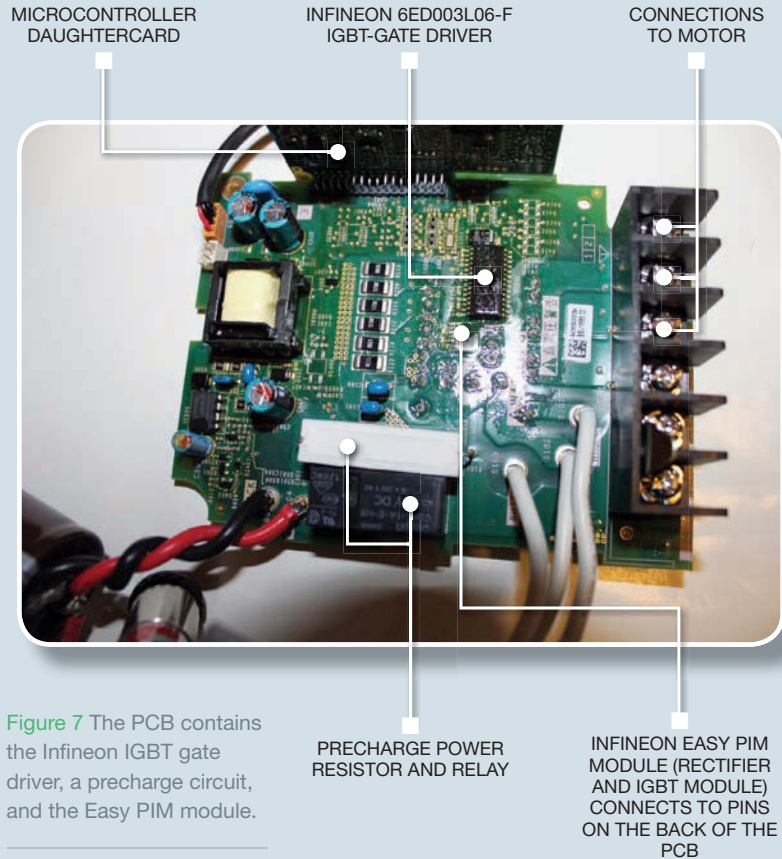
**Figure 6** The Altivar 12 heat-sink assembly for the Infineon Easy PIM module mechanically connects on the flat rear surface of the heat sink and thermally connects with thermal grease.

Motor-drive applications require galvanic isolation for the IGBTs' gate drive for bridge inverters and for motor-phase current sensing. In this case, the SOI substrate is fully isolated from the rest of the circuit. The high-voltage precharge circuit minimizes the peak current from the power source by slowing down the  $dV/dT$  of the input-power voltage, thus implementing a new precharge mode.

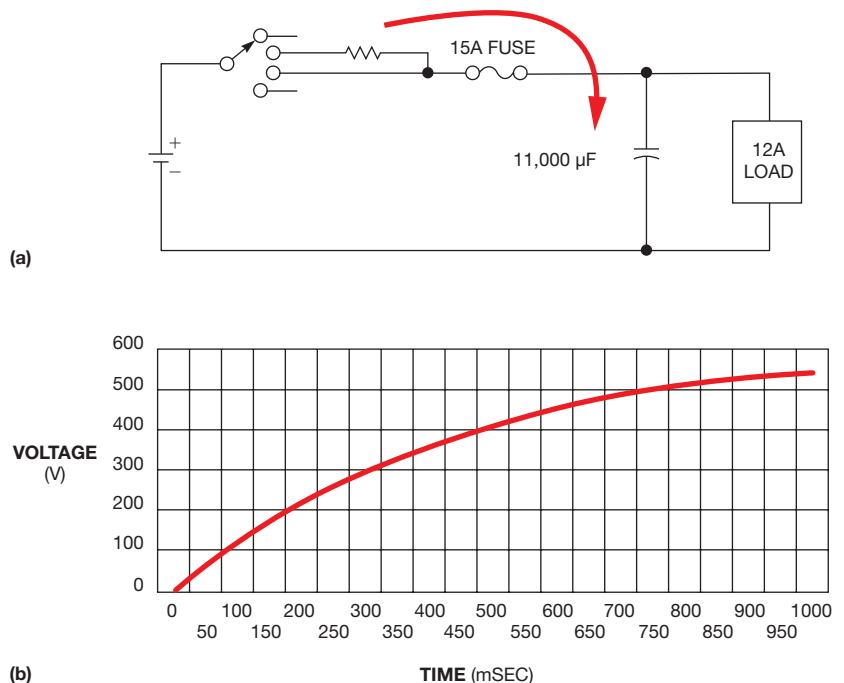
You must switch off the inductive loads on the distribution system during the precharge mode. During precharging, the system voltage rises slowly and controllably, with power-up current never exceeding the allowed maximum. As the circuit voltage approaches near steady state, the precharge function completes. The normal goal of a precharge circuit is to terminate precharge mode when the circuit voltage is 90 or 95% of the operating voltage.

Upon completion of precharging, the precharge resistance switches from the power-supply circuit and returns to a low-impedance power source for normal mode. The high-voltage loads then power up sequentially. This step keeps the capacitor from overstressing. When you apply dc power to a capacitor, the capacitor instantly sees this action as a short circuit, causing a large inrush current from the source (**Figure 8**).

A microprocessor controls the



**Figure 7** The PCB contains the Infineon IGBT gate driver, a precharge circuit, and the Easy PIM module.



**Figure 8** A precharging example (a) shows how the relay switches in a power resistor to limit inrush current to the capacitor, thereby extending capacitor life (b).

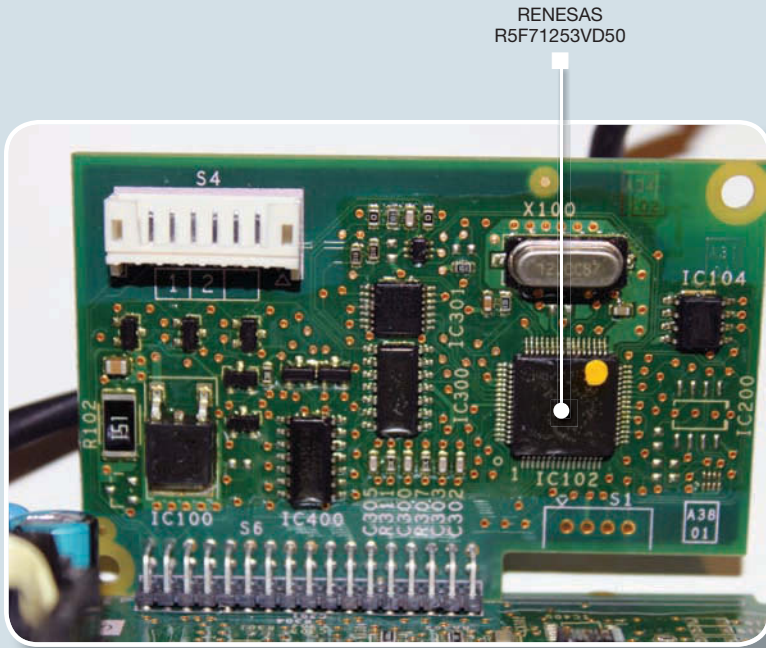


Figure 9 The microcontroller's daughtercard performs the inverter function.



Figure 10 The display board normally resides behind the front panel, and a Renesas microcontroller drives and controls the display and the Modbus-serial-port connection.

process by monitoring the incoming voltage supply, speed setpoint, dc-link voltage, and output voltage and current to ensure operation of the motor within established parameters. The Altivar 12 designers used the 32-bit RISC Renesas R5F71253VD50 microcontroller SuperH device, which incorporates timer units that generate three-phase PWM waveforms with dead time and a 12-bit ADC for inverter control (Figure 9).

**THE DEVICE USES A MODBUS SERIAL PORT TO CONNECT TO EXTERNAL SOFTWARE, THE MODBUS INDUSTRIAL NETWORK, OR A REMOTE DISPLAY. THIS MULTIFUNCTION DESIGN SAVES SPACE AND COST.**

The device uses a Modbus serial port to connect to external software, the Modbus industrial network, or a remote display (Figure 10). The 16-bit Renesas R5F3640 microcontroller handles the display functions and translates motor- and drive-status conditions to display messages. The potentiometer connects to the front-panel jog dial and acts as a potentiometer in local mode for navigation when clockwise or counterclockwise and selection and validation when pushed. This multifunction design saves space and cost. The Omron G5RL power relay provides remote indication of drive status on the board. **EDN**

## REFERENCE

1 "IP-Ingress Protection Ratings," The Engineering ToolBox, <http://bit.ly/GLW5LK>.

You can reach Senior Technical Editor **Steve Taranovich** at 1-516-562-7051 and [steve.taranovich@ubm.com](mailto:steve.taranovich@ubm.com).



## Convert 1 to 5V signal to 4- to 20-mA output

Thomas Mosteller, Linear Technology Corp

Despite the long-predicted demise of the 4- to 20-mA current loop, this analog interface is still the most common method of connecting current-loop sources to a sensing circuit. This interface requires the conversion of a voltage signal—typically, 1 to 5V—to a 4- to 20-mA output. Stringent accuracy requirements dictate the use of either expensive precision resistors or a trimming potentiometer to calibrate out the initial error of less precise devices to meet the design goals.

Neither technique is optimal in today's surface-mounted, automatic-test-equipment-driven production environment. It's difficult to get precise resistors in surface-mount packages, and trimming potentiometers require human intervention, a requirement that

is incompatible with production goals.

The Linear Technology LT5400 quad matched resistor network helps to solve these issues in a simple circuit that requires no trim adjustments but achieves a total error of less than 0.2% (Figure 1). The circuit uses two amplifier stages to exploit the unique matching characteristics of the LT5400. The first stage applies a 1 to 5V output—typically, from a DAC—to the noninverting input of op amp  $IC_{1A}$ . This voltage sets the current through  $R_1$  to exactly  $V_{IN}/R_1$  through FET  $Q_2$ . The same current is pulled down through  $R_2$ , so the voltage at the bottom of  $R_2$  is the 24V loop supply minus the input voltage.

This portion of the circuit has three main error sources: the matching of  $R_1$  and  $R_2$ ,  $IC_{1A}$ 's offset voltage, and  $Q_2$ 's

### DIs Inside

47 Linearize optical distance sensors with a voltage-to-frequency converter

50 Use a transistor as a heater

51 Monitor circuit conserves battery energy

► To see and comment on all of EDN's Design Ideas, visit [www.edn.com/designideas](http://www.edn.com/designideas).

leakage. The exact values of  $R_1$  and  $R_2$  are not critical, but they must exactly match each other. The LT5400A grade achieves this goal with  $\pm 0.01\%$  error. The LT1490A has less-than-700- $\mu$ V offset voltage over 0 to 70°C. This voltage contributes 0.07% error at an input voltage of 1V. The NDS7002A has a leakage current of 10 nA, although it is usually much less. This leakage

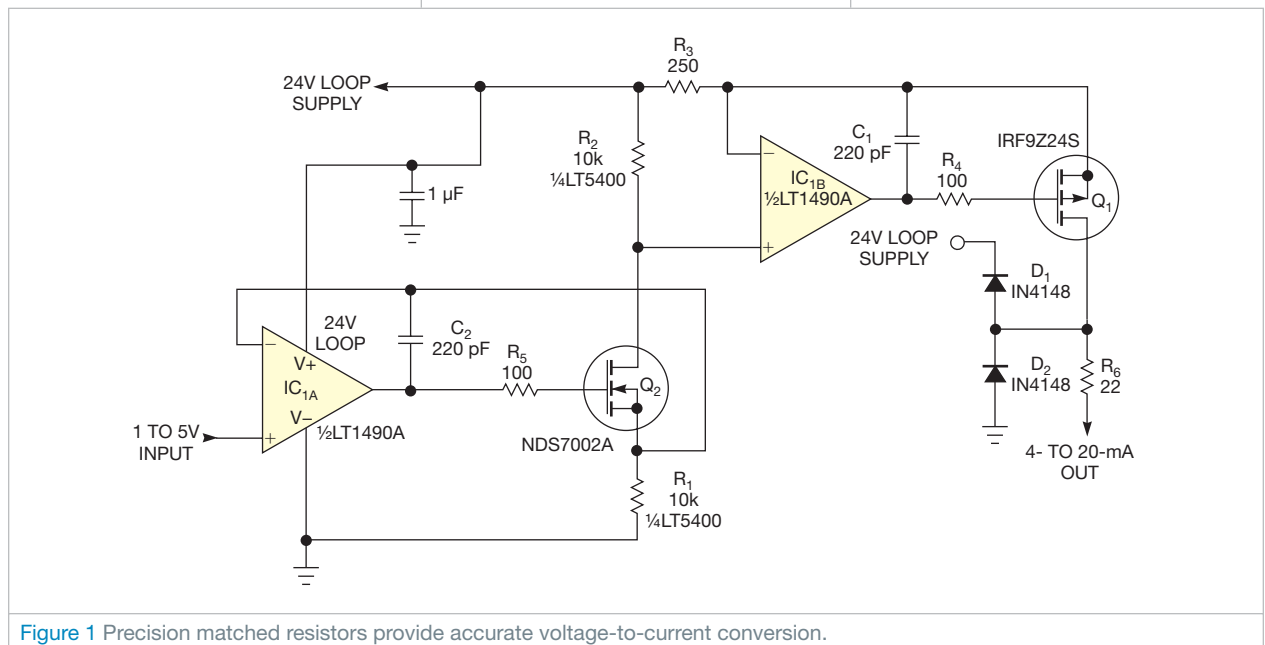


Figure 1 Precision matched resistors provide accurate voltage-to-current conversion.



current represents an error of 0.001%.

The second stage holds the voltage on  $R_3$  equal to the voltage on  $R_2$  by pulling current through  $Q_1$ . Because the voltage across  $R_2$  equals the input voltage, the current through  $Q_1$  is exactly the input voltage divided by  $R_3$ . By using a precision  $250\Omega$  current shunt for  $R_3$ , the current accurately tracks the input voltage.

The error sources for the second stage are  $R_3$ 's value,  $IC_{1B}$ 's offset voltage, and  $Q_1$ 's leakage current. Resistor  $R_3$  directly sets the output current, so its value is crucial to the precision of the circuit. This circuit takes advantage of the commonly used  $250\Omega$  current-loop-completion shunt resistor. The Riedon SF-2 part in the figure has 0.1% initial accuracy

and low temperature drift. As in the first stage, offset voltage contributes no more than 0.07% error.  $Q_1$  has less than 100-nA leakage, yielding a maximum error of 0.0025%.


Total output error is better than 0.2% without any trimming. Current-sensing resistor  $R_3$  is the dominant source of error. If you use a higher-quality device, such as the Vishay PLT series, you can achieve an accuracy of 0.1%. Current-loop outputs are subject to considerable stresses in use. Diodes  $D_1$  and  $D_2$  from the output to the 24V loop supply and ground help protect  $Q_1$ ;  $R_6$  provides some isolation. You can achieve more isolation by increasing the value of  $R_6$ , with the trade-off of some compliance voltage at

the output. If the maximum output-voltage requirement is less than 10V, you can increase  $R_6$ 's value to  $100\Omega$ , affording even more isolation from output stress. If your design requires increased protection, you can fit a transient-voltage suppressor to the output with some loss of accuracy due to leakage current.

This design uses only two of the four matched resistors in the LT5400 package. You can use the other two for other circuit functions, such as a precision inverter, or another 4- to 20-mA converter. Alternatively, you can place the other resistors in parallel with  $R_1$  and  $R_2$ . This approach lowers the resistor's statistical error contribution by the square root of two. **EDN**

## Linearize optical distance sensors with a voltage-to-frequency converter

Jordan Dimitrov, Toronto, ON, Canada

 A popular series of inexpensive distance sensors integrates an infrared emitting diode, a linear charge-coupled-device array, and a signal-processing circuit in one unit. The output is a dc voltage,  $V_s$ , that depends on the distance,  $D$ , in a non-linear manner (Figure 1).

To improve linearity, the manufacturer suggests using the relationship between the output voltage and the inverse value of the distance (Figure 2). You can use the curve-fitting utility of Excel software to calculate two or three

coefficients of this alternative relationship, and a microcontroller can then use the coefficients to calculate distance from  $V_s$ . The calculation requires floating-point arithmetic, which results in a large amount of machine-language code, a difficulty for many microcontrollers due to their limited memory size.

This Design Idea describes a way to present the sensor response with better linearity and a circuit that eliminates the need for complex calculations to find the distance. The built-and-tested unit uses the Sharp GP2D120 sensor

(Reference 1), which measures distances of 4 to 30 cm (40 to 300 mm). This sensor is currently out of production but may be available through some sources. If not, a similar but untested replacement is the Sharp GP2Y0A21YK0F (Reference 2), which measures distances of 10 to 80 cm (100 to 800 mm).

Figure 3 shows the linearity improvement you gain by using the inverse value of the voltage,  $V_s$ , versus distance. Figure 4 shows the circuit that provides a linear relationship between distance and another variable. The key component is a voltage-to-frequency converter, such as the AD654, between the sensor and the microcontroller (references 3 and 4). The sensor's response is  $1/V_s = aD + b$ , where  $a$  and  $b$  are coefficients. The VFC has a linear

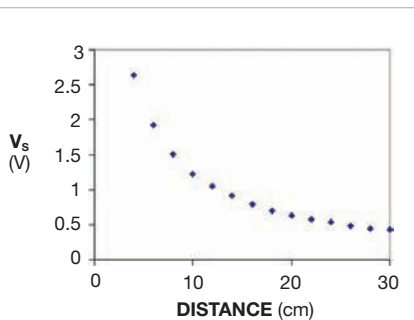


Figure 1 The analog voltage directly from the sensor is not linear with the distance.

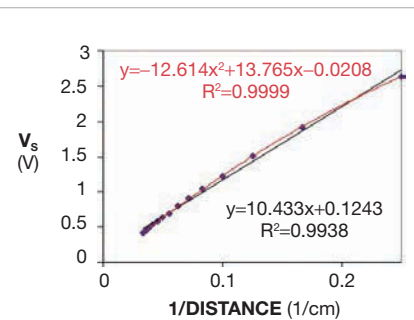


Figure 2 Plotting the voltage against the inverse of the distance improves the linearity.

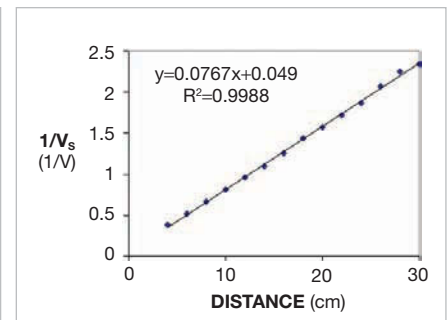
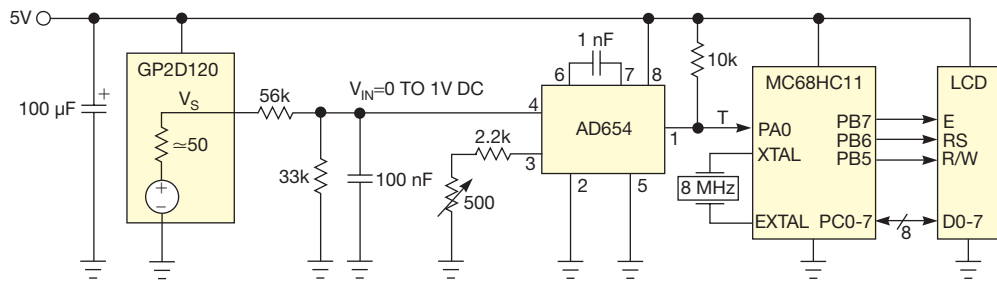


Figure 3 The new way of presenting the inverse of the sensor voltage against the distance provides the best linearity.



**Figure 4** An AD654 VFC between the sensor and the microcontroller ensures a linear relation between pulse period and distance. A measurement calculates the 50Ω output impedance of the distance sensor. The LCD can be any generic device.

## LISTING 1 DISTANCE-CALCULATION CODE

```

Measure  LDAA    #$01          ; Clear IC3 flag
          STAA    TFLG1,X
          BRCLR   TFLG1,X,$01 * ; Wait for a rising edge
          LDD     TIC3,X
          STD     t1          ; Save time of pulse edge
          LDAA    #$01          ; Clear IC3 flag
          STAA    TFLG1,X
          BRCLR   TFLG1,X,$01 * ; Wait for the next rising edge
          LDD     TIC3,X
          STD     t2          ; Save time of 2nd pulse edge
          SUBD    t1          ; Calculate period
          SUBD    #10         ; Remove offset of the cal line
          STD     N           ; Save result
          RTS
    
```

response,  $f=S_F V_S$ , where  $S_F$  is a coefficient. The pulse period is  $T=1/f$ . The microcontroller defines the period as a number of internal clock pulses,  $N=T/T_{CLK}$ . The period of clock pulses is 0.5 µsec, and it defines the values of the frequency-determining components of the VFC. From these equations, you can build a relationship between  $N$  and  $D$ :  $N=(aD+b)/(S_F \times T_{CLK})$ , which is a straight line. The hardware circuit's design performs the calculations; they do not take place when the microcontroller calculates distance.

The RC network at the sensor output matches the sensor-voltage swing to the VFC's input range and attenuates the 1-kHz noise riding on the sensor signal. The resistor divider modifies the system response to the form  $N=(aD+b)/(k_D \times S_F \times T_{CLK})=\alpha \times D+\beta$ , where  $k_D$  is the transfer ratio of the divider,

$\alpha$  is the slope, and  $\beta$  is the offset.

Listing 1 shows the subroutine code for measuring and calculating the distance. Calibration is somewhat tedious because the sensor cannot measure zero distance. You adjust the slope of the last equation by using two reference distances and tweaking the 500Ω trimming potentiometer at the VFC. If the reference distances are 80 and 220 mm, you must adjust for a difference of 140 between the corresponding numbers on the display. When you finish that task, use any of the reference numbers to calculate the offset. In the code, subtract the offset from the measured value of  $N$ . A test of the assembled circuit covers the whole measurement range in steps of 20 mm. The nonlinearity error is  $\pm 3$  mm, 2.7 times smaller than the error of the  $V_S$ -versus- $1/D$  response.

**Editor's note:** The author teaches

a course on microcontrollers at a large community college in Toronto, ON, Canada. The course inspired this Design Idea. The Sharp distance sensor is an opportunity to show students that they can perform linearization using software or hardware, and they can compare the two approaches. **EDN**

## REFERENCES

- 1 "GP2D120 Optoelectronic Device," Sharp Microelectronics, 2006, <http://bit.ly/Ap41QU>.
- 2 "GP2Y0A21YK0F Distance Measuring Sensor Unit," Sharp Microelectronics, Dec 1, 2006, <http://bit.ly/y1o7g3>.
- 3 "HC11 MC68HC11F1 Technical Data," Freescale Semiconductor Inc, <http://bit.ly/A78Fq0>.
- 4 "AD654 Low Cost Monolithic Voltage-to-Frequency Converter," Analog Devices, <http://bit.ly/AyRHT6>.

# Navigate to the Future

*Maxim speeds you past integration challenges on the road ahead*



**More multimedia. More sensors. More fuel efficiency.** In 2012, the key word is "more." But cars aren't getting any bigger. And your job isn't getting any easier. At Maxim, we're used to tackling even the most daunting integration challenges. So whether you need more performance on board—or more functions in a chip—we can help you get there faster.

## Featured Technologies

- GMSL SerDes chipset with coax drive halves cabling costs for in-vehicle networks, so you can add new multimedia and safety systems at a much lower price point
- Battery-monitoring ICs feature a patented SMBus daisy-chain interface to improve safety, performance, and reliability in hybrid and electric vehicles
- Multi-output PMICs supply all the power rails you need to integrate functions like voice control, MP3 playback, and USB connectivity into infotainment systems
- Fully integrated RF tuners deliver new levels of performance for active antennas, mobile TV, HD radio, and universal GPS

Learn about these and other automotive solutions.

[www.maxim-ic.com/Auto-Ad](http://www.maxim-ic.com/Auto-Ad)

**MAXIM**  
INNOVATION DELIVERED®

**MAXIM**  
DIRECT

[www.maxim-ic.com/shop](http://www.maxim-ic.com/shop)

**AVNET**  
electronics marketing

[www.em.avnet.com/maxim](http://www.em.avnet.com/maxim)

**Digi-Key**  
electronics

[www.digikey.com/maxim](http://www.digikey.com/maxim)

**MOUSER**  
ELECTRONICS

[www.mouser.com/maximic](http://www.mouser.com/maximic)

© 2012 Maxim Integrated Products, Inc. All rights reserved. Innovation Delivered, Maxim, and the Maxim logo are trademarks or registered trademarks of Maxim Integrated Products, Inc., in the United States and other jurisdictions throughout the world. All other company names may be trade names or trademarks of their respective owners.



## Use a transistor as a heater

REC Johnson, B Lora Narayana, and Devender Sundi,  
Center for Cellular and Molecular Biology, Hyderabad, India

It is common to use transistors for driving resistive heating elements. However, you can use the heat that a power transistor dissipates to advantage in several situations, eliminating the need for a separate heating element because most transistors can safely operate at temperatures as high as 100°C. A typical example is in a biological laboratory, in which the need for maintaining the temperature of samples in microliter-sized cuvettes is a common requirement. The space/geometry constraint and the less-than-100°C upper-temperature limit are the basic factors of the idea.

You can use an N-channel IRF540 MOSFET to directly heat and control the temperature of a biological sample from ambient to 45°C. **Figure 1** shows a simple on/off-type control circuit in which an LM35, IC<sub>1</sub>, is the temperature sensor, whose output a DPM

(digital panel meter) can display. IC<sub>2</sub> compares the voltage that VR<sub>1</sub> sets with the output of the LM35 to turn on Q<sub>2</sub> accordingly, with the positive feedback through R<sub>9</sub> providing a small amount of hysteresis. S<sub>1</sub> switches the DPM between a set value and the actual temperature readout. You derive the reference voltage from a TL431 shunt regulator (not shown). The LED lights up when Q<sub>2</sub> is on.

IC<sub>1</sub> and Q<sub>2</sub> thermally mount on the metal block that forms the sample holder; use thermal grease on both components for maximum heat transfer. Note that the mounting tab of the TO-220 package electrically connects to the drain, and you may need to insulate it from the cuvette with a thermal pad. Setting bias control VR<sub>3</sub> for a Q<sub>2</sub> current of 270 mA is sufficient to hold the cuvette at 45°C.

Be sure to set VR<sub>3</sub> to minimum power during initial power-up; if you

set it for maximum power, you could apply 24V to Q<sub>2</sub>'s gate-to-source voltage, which is rated for a maximum of only 20V. You can extend the temperature range by changing the voltage divider comprising R<sub>1</sub>, R<sub>2</sub>, and VR<sub>1</sub>. The design includes a safety cutoff circuit (not shown) in case the temperature gets too high.

**YOU CAN USE THE HEAT THAT A POWER TRANSISTOR DISSIPATES TO ADVANTAGE, ELIMINATING THE NEED FOR A SEPARATE HEATING ELEMENT.**

Various other options are also possible applications for this circuit. These applications include linear control, pulse-width modulation, and the use of a PID (proportional-integral-derivative) controller, to name a few. **EDN**

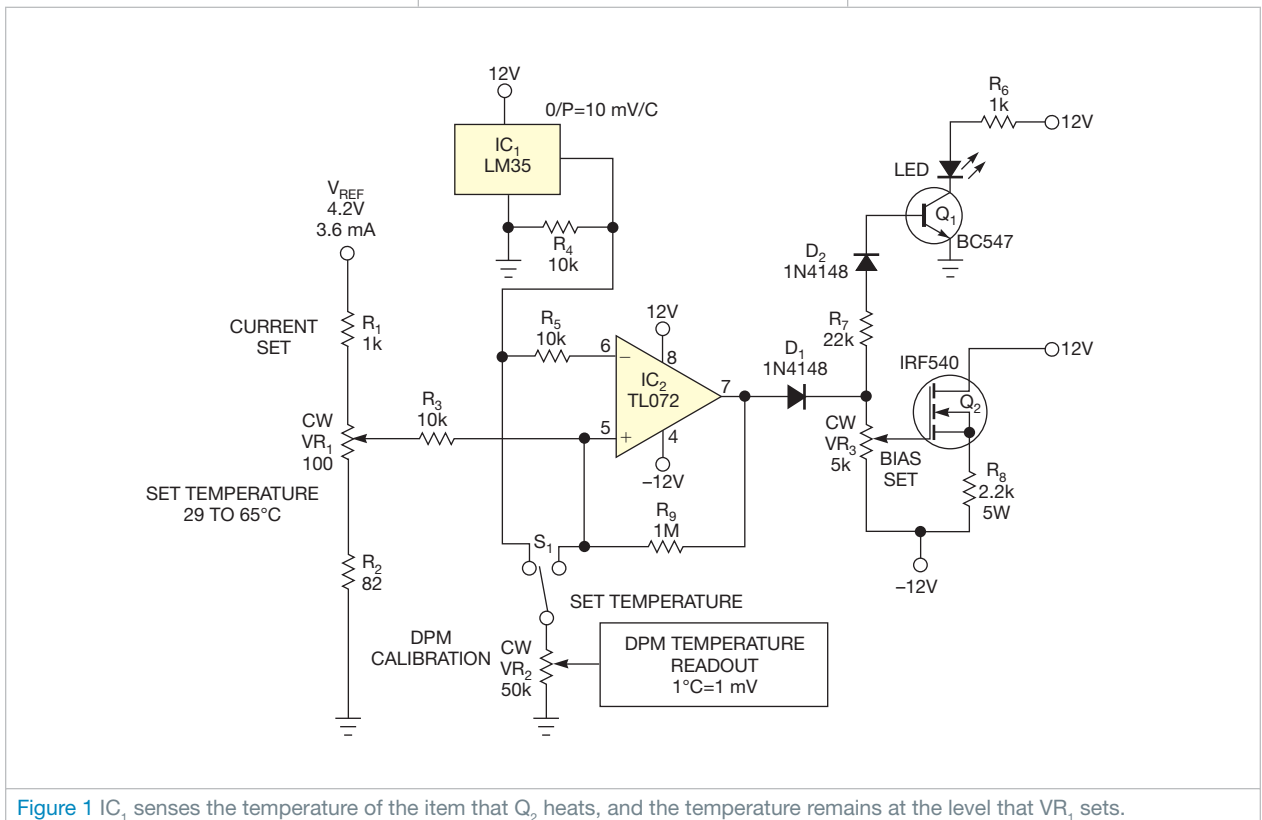


Figure 1 IC<sub>1</sub> senses the temperature of the item that Q<sub>2</sub> heats, and the temperature remains at the level that VR<sub>1</sub> sets.

Originally published in the August 20, 1990, issue of EDN

## Monitor circuit conserves battery energy

Brian Huffman, Linear Technology Corp, Milpitas, CA

Many battery-powered systems require a visual indication when the battery needs replacement. LEDs often serve as the indicator, but they can draw as much as 10 mA of current. This excessive current drain unduly accelerates the battery's discharging and curtails the battery's useful life. **Figure 1** uses a sampled-data technique to lower the monitor circuit's average power consumption. The circuit draws 5  $\mu\text{A}$  of standby current and 30  $\mu\text{A}$  during low-battery indication.

During a sampling cycle, the LTC1041 bang-bang controller applies power to both of its internal comparators; samples the  $V_{\text{IN}}$ , SET POINT, and DELTA inputs; stores the results of the comparisons in an output latch; and turns off power. This process takes

approximately 80  $\mu\text{sec}$ . An external RC network consisting of  $R_1$  and  $C_1$  sets the sampling rate.

The controller's  $V_{\text{PP}}$  output switches to  $V_{\text{CC}}$  during the controller's active 80- $\mu\text{sec}$  on time and switches to a high impedance during off time. A fast-settling reference sets the trip points.  $R_2$  must be small enough to supply the LT1009's minimum required current.  $R_3$ ,  $R_4$ , and  $R_5$  divide the battery voltage and feed it into a comparator input. The resistors provide a lower trip point of 5.5V and an upper trip point of 5.95V. The internal comparators' low-current bias point permits using high-valued resistors for the divider.  $R_5$  sets the comparator's hysteresis. The comparators drive an internal RS flip-flop; the flip-flop is set (ON/OFF= $V_{\text{CC}}$ ) when



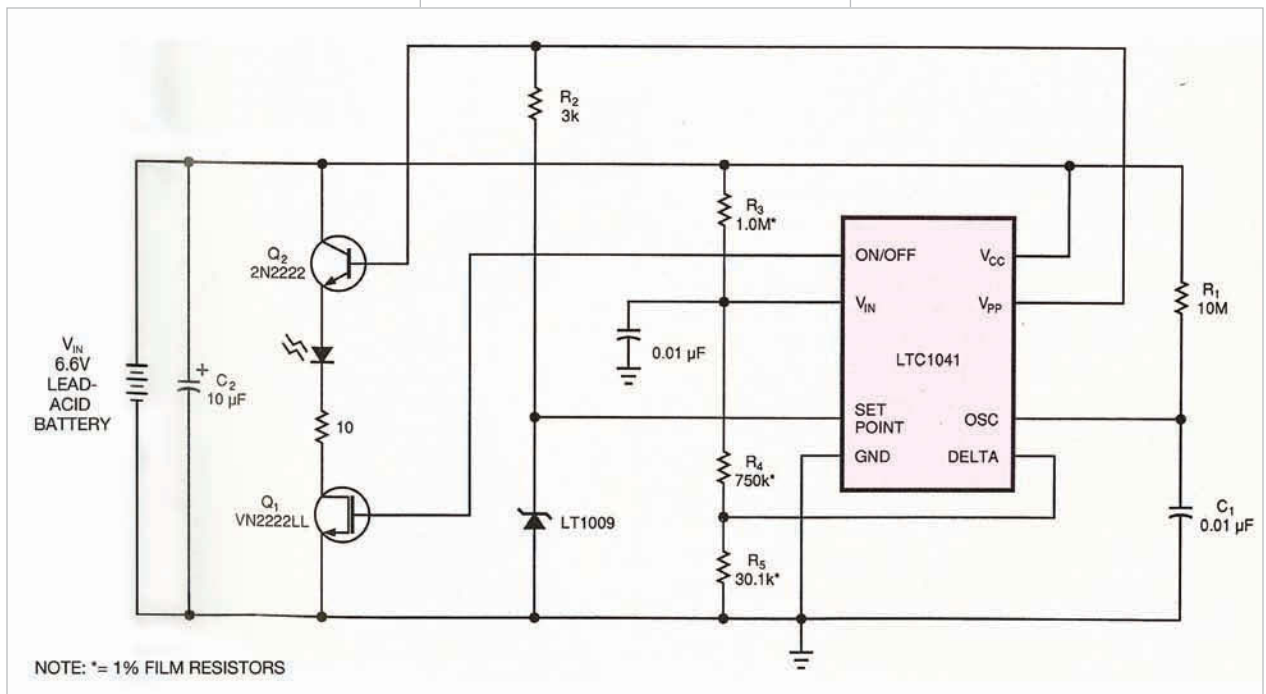
**WANT TO SEE MORE OF THE CLASSICS?**

Revisit 50 of the best Design Ideas from the Golden Age of electrical engineering.

<http://bit.ly/DesignIdeasClassics>

$V_{\text{IN}} < \text{SET POINT} - \text{DELTA}$ . The flip-flop is reset (ON/OFF=ground) when  $V_{\text{IN}} > \text{SET POINT} + \text{DELTA}$ .

When the controller reaches the lower trip point, the flip-flop latches, turning on  $Q_1$ . Once latched, the  $V_{\text{PP}}$  output drives  $Q_2$ , causing the LED to flash at each sampling cycle. The circuit drives the LED with 75 mA for 80  $\mu\text{sec}$  every 220 msec. This operation results in an average current drain of 27  $\mu\text{A}$ . The LED may flash once during power up because the latch output is temporarily indeterminate. A bypass capacitor,  $C_2$ , ensures low-supply impedance under transient loads. **EDN**



**Figure 1** Instead of continuously draining the battery, this monitor circuit samples the inputs to achieve power consumption of 5  $\mu\text{A}$  in standby and 30  $\mu\text{A}$  during low-battery indication.

# supplychain

LINKING DESIGN AND RESOURCES

## Shipping now: conflict-free parts

**A**VX Corp and Motorola Solutions Inc have announced the first shipment of tantalum products that the companies have validated as “conflict-free.” AVX is using tantalite ore from US-government-approved sources in the DRC (Democratic Republic of the Congo) in its components.

The components are the result of SFH (Solutions for Hope), a cooperative effort between AVX and Motorola, which enables companies to meet the impending requirements from the Dodd-Frank Act. The act, signed into law in 2010, stipulates that US companies must disclose the use of certain minerals, including tantalum,

in their products and ensure that the minerals do not fund illegally armed groups operating in the DRC.

The supply-chain process, which AVX controls, is a closed-pipe system, in which the ore, mined from government-approved sources, is traced from the mine to the customer. According to SFH, the minerals come from the Mai Baridi, Kisengo, and Luba mines in the northern area of the DRC. MMR (Mining Minerals Resources) SPRL has the mining rights and has contracted with a local

mining co-op, which mines the minerals using a semimechanized process.

After collecting the minerals, MMR weighs and logs them for traceability. The company then transfers them to an MMR depot in Kalemie, DRC, for export. AVX takes ownership of the minerals at this point and transports them to a smelter, which turns them into tantalum powder and ships them



to AVX's facility in the Czech Republic for use in tantalum capacitors.

To ensure validation of each step in the process, the companies conducted due diligence before launching the operation, including a review of the mine to determine its conflict-free status. After this status was confirmed, the mine began the traceability process of bagging and tagging. Gregory Mthembu-Salter, a consultant to the United Nations Group of Experts, conducted an independent audit of the operation

to evaluate its conformance with guidelines of the Office of Environmental Compliance and Due Diligence. The findings indicated that the mine and trade routes are conflict-free but highlighted areas for improvement to the mining-operations systems.

The mining operations have hired a consultant to help address the issues that the report identified, and AVX uses

Alfred H Knight, an independent organization, to conduct a number of analytical checks to validate the traceability mechanisms. Alfred H Knight takes samples at the mine; the depot at the point of export; the warehouse in Johannesburg,

South Africa; and again at the smelter.

AVX also audits the smelter for compliance. The smelter can “semibatch” treated materials so that the company can track these materials through the smelting process to ensure that the DRC sends the conflict-free materials to AVX.

Intel, Hewlett-Packard, Foxconn, and Nokia have joined the SFH effort.

—by Barbara Jorgensen,  
EBN Community Editor

*This story was originally posted by EBN: <http://bit.ly/HembfY>.*

## HARD-DISK-DRIVE-INDUSTRY GROWTH HITS RESET BUTTON

OUTLOOK

**After suffering** a year-over-year decline of 4.5% in 2011, largely due to flooding in factories caused by natural disasters, the hard-disk-drive industry should record year-over-year unit-shipment growth of 7.7% in 2012 and a CAGR (compound annual growth rate) of 9.6% for 2011 through 2016, according to research firm IDC.

IDC notes that, due to the imbalance in supply and demand that resulted from the floods in Thailand, hard-disk-drive prices have increased in recent months. IDC expects year-over-year hard-drive revenue growth to exceed shipment growth in 2012, a precedent for the industry. If the industry is successful with hybrid solid-state hard drives, revenue could approach \$50 billion by 2016, the company estimates.

“In many respects, the hard-disk-drive industry has collectively hit the ‘reset’ button,” says John Rydning, research vice president for hard-disk drives at IDC. Nevertheless, Rydning believes that the industry can realize long-term revenue growth only if the remaining participants transform into storage-device and storage-solution suppliers with a range of products for a variety of markets.

—by Suzanne Deffree



# Support Across The Board.<sup>TM</sup>

## From Design to Delivery<sup>TM</sup>



### Now, you can have it all.<sup>TM</sup>

Faster and easier than ever before. Our commitment to customer service is backed by an extensive product offering combined with our supply chain and design chain services – which can swiftly be tailored to meet your exact needs. We have dedicated employees who have the experience to provide the highest level of customer service with accuracy and efficiency. All of our technical experts are factory certified on the latest technologies, providing you the expertise to move projects forward with speed and confidence.

Avnet offers the best of both worlds: extensive product and supply chain knowledge, and specialized technical skill which translates into faster time to market – and the peace of mind that comes from working with the industry's best. **Avnet is ranked Best-In-Class\* for well-informed sales reps, knowledgeable application engineers and our design engineering services – proof that we consistently deliver:**

- > Industry recognized product expertise
- > Specialized technical skills

#### Ready. Set. Go to Market.<sup>TM</sup>

Visit the Avnet Design Resource Center<sup>TM</sup> at:  
[www.em.avnet.com/drc](http://www.em.avnet.com/drc)



*Accelerating Your Success<sup>TM</sup>*



\*As rated by Hearst Electronics Group: The Engineer & Supplier Interface Study, 2009.  
©Avnet, Inc. 2011. All rights reserved. AVNET is a registered trademark of Avnet, Inc.

1 800 332 8638  
[www.avnetexpress.com](http://www.avnetexpress.com)

Follow us on Twitter!  
[www.twitter.com/avnetdesignwire](http://www.twitter.com/avnetdesignwire)



# productroundup

## CIRCUIT PROTECTION



### Diodes' AP2331 load switch targets HDMI-port protection

↘ The 0.2A-rated, SOT-23-packaged, single-channel, current-limited AP2331 load switch complies with the HDMI standard and targets HDMI- and monitor-port protection, 3 to 5V hot-swap interconnects, and other applications subject to heavy capacitive loads and short circuits. The device features built-in soft-start and a typical turn-on time of 0.7 msec. Features include an input-voltage range of 2.7 to 5.2V, 0.4A accurate current limiting, reverse-current blocking, overcurrent and overvoltage protection, and an ambient temperature range of -40 to +85°C. The devices sell for 5 cents (1000).

**Diodes Inc, [www.diodes.com](http://www.diodes.com)**

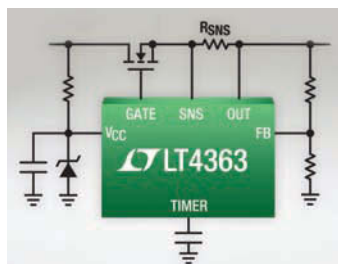
### Linear LT4363 surge stopper shields sensitive circuits

↘ The LT4363 overvoltage-protection controller employs a clamp to extend protection beyond 100V and survives reversed-battery connections to -60V. The device features an operating voltage of 4 to 80V, an overcurrent limit of less than 5  $\mu$ sec, and adjustable undervoltage and overvoltage thresholds. Shutdown

current is 7  $\mu$ A, and the shutdown pin withstands -60 to +100V. A built-in thermal shutdown occurs at approximately 150°C. The device is available as the LT4363-1, which latches off after a fault, and the LT4363-2, which retries after a long cool-down period.

The device comes in 12-pin, 4x3-mm DFN packages; MSOPs; and 16-pin SOPs with high-voltage pin spacing. Prices begin at \$2.48 (1000).

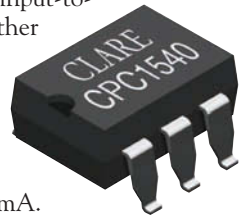
**Linear Technology Corp, [www.linear.com](http://www.linear.com)**



### Clare CPC1540 SSR has thermal shutdown

↘ The CPC1540 OptoMOS solid-state relay incorporates active current limiting and thermal shutdown for harsh environments. A 350V load voltage rating ensures compatibility with telephony ring voltages and provides 3750V rms of input-to-output isolation. Other key specs include a load current of 120 mA, maximum on-resistance of 25 $\Omega$ , and an input-control current of 2 mA. Targeting ac and dc space-limited applications, the CPC1540 sells for 89 cents (25,000).

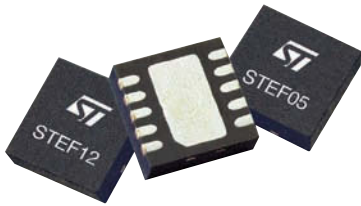
**Clare Inc, [www.clare.com](http://www.clare.com)**



### STMicro STEF05 and STEF12 fuses ease hot-swap design

↘ The STEF05 and STEF12 electronic fuses have 5 and 12V ratings, respectively, and can replace larger conventional fuses or other protection devices. Unlike fuses, however, they neither suddenly cut power nor require replacement after actuating. The 3x3-mm devices restrict the supply current, thus protecting the connected circuitry, and turn off the protected equipment if a fault persists. A signal from the system or restarting the power supply resets the fuses, which provide a signal when they are intervening, allowing the system to generate a warning. If the fault persists, the fuses immediately limit the current and turn off to protect the circuitry. The devices integrate circuitry that limits voltage fluctuations to the protected load; a programmable start-up time, through an external capacitor, allows use in hot-swappable modules for enterprise servers, storage,






or telecom systems. The devices come in 10-lead packages, and prices start at 75 cents (1000).

**STMicroelectronics, [www.st.com](http://www.st.com)**

## TT Electronics' OPI1268S optoisolator has 20-kV isolation


 The OPI1268S optoisolator, from TT Electronics' Optoelectronic business unit, is designed for transportation and PCB power systems, features 20-kV isolation, less-than-50-nsec typical propagation delay, and a 2-Mbps transfer rate. The device also provides a voltage-spike immunity of 30-kV/ $\mu$ sec dv/dt. Other features include an input diode with a maximum forward voltage of 1.8V at a forward current of 20 mA and a continuous forward current of 50 mA. Maximum reverse current is 100  $\mu$ A, and reverse voltage is 3V. The output IC operates with a 7V supply voltage with 40-mW power dissipation. Operating temperature range is -50 to +100°C.



The OPI-1268S comes in a five-lead configuration measuring 27.9x6.35x8.89 mm and is available from Digi-Key for approximately \$5.32 (2500).

**TT Electronics, [www.optekinc.com](http://www.optekinc.com)**

## On Semi ESD7008, MG2040, and ESD7104 suppress transient voltages


 The ESD7008 transient-voltage suppressor protects as many as four high-speed differential pairs (eight lines), with I/O-to-ground capacitance of 0.12 pF. In a flow-through UDFN18 package, the device supports easy PCB layout and matched trace lengths to maintain consistent impedance for high-speed lines. The MG2040 transient-voltage suppressor integrates ESD

protection for as many as 14 lines serving all active pins of HDMI and DisplayPort interfaces. The device touts a typical I/O-to-ground capacitance of 0.35 pF, a flow-through package design, and a low ESD clamping voltage. The ESD7104 transient-voltage suppressor protects as many as four lines; comes in a UDFN10 package; and allows easy layout for HDMI, USB 3.0, eSATA 3.0, and DisplayPort applications. Typical I/O-to-ground capacitance is 0.3 pF. All three devices operate at an operating-temperature range of -55 to +125°C and exceed the protection requirements of IEC 6100-4-2 by protecting more than 15-kV contact and air discharge. Prices range from 15 to 30 cents (10,000).



**On Semiconductor, [www.onsemi.com](http://www.onsemi.com)**

## B&B UHR401 and UHR402 USB isolators withstand hazards

 The one-port Ulinx UHR401 and two-port Ulinx UHR402 USB isolators withstand industrial-networking hazards, including shock, drop, vibration, EMI, and temperature extremes. Applications include industrial control and manufacturing, remote sensing, and POS. They feature high-retention ports that hold USB cables firmly in place, requiring 3.2 lbs of force to dislodge one, to eliminate data loss and the risk of fire that loose cables and arcing can cause. The isolators operate at -40 to +80°C and provide 15-kV-air and 8-kV-contact ESD protection and 4-kV isolation between the upstream and the downstream USB ports. Downstream ports provide 500-mA power to connected devices. The devices come with an external power



supply that has US, EU, and UK blades. A locking barrel plug is optional. The UHR401 and UHR402 sell for \$169

# Look to NIC Components for Your Performance Passives...



**NIC's Performance Passive Lineup Focuses on Precision, Reliability, and the Quality You Expect for Your Designs:**

**Hybrid Electrolytic Capacitors  
LowESR Capacitors  
Long Life, High Voltage Capacitors**

**RF Ceramic Capacitors  
SMT Film Capacitors**

**Power Inductors  
RF Chip Inductors  
EMI Suppression**

**Thin Film Resistors  
Current Sensing Resistors  
SMT Circuit Protection**

Search, Cross, & Design With  
**QuickBUILDER**

View Parts by Reference With  
**DesignKITS**

**30**  
1982 ~ 2012  
Years of Service

Visit **NICcomp.com** to search  
NIC's Entire Offering!



**NIC**  
**NIC Components Corp.**



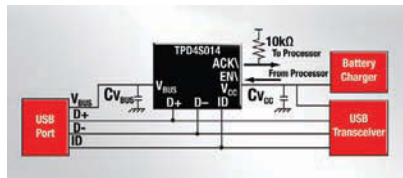
# productroundup

and \$179 (one), respectively, including a five-year warranty.

**B&B Electronics Manufacturing Co.**, [www.bb-elec.com](http://www.bb-elec.com)

## TI's TPD4S014 protects USB ports against ESD and overvoltage

↘ The TPD4S014 USB-protection device for all four USB channels measures only 2 mm<sup>2</sup>. The device protects against ESD, overvoltage, overcurrent, and overtemperature, turning off the switch to the power rail if the junction



temperature exceeds 150°C. The device provides ESD immunity of ±8-kV contact discharge and ±15-kV air-gap discharge and is compatible with both full- and high-speed USB, supporting data rates as high as 480 Mbps. The TPD4S014 comes in a 10-pin, 4-mm<sup>2</sup> DSQ SON package and sells for 55 cents (1000).

**Texas Instruments**, [www.ti.com](http://www.ti.com)

## Bourns evaluation boards target RS-485 applications

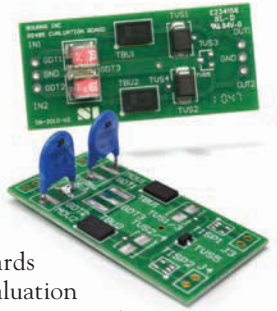
↘ The RS-485 evaluation board 1 includes two transient-blocking-unit high-speed protectors, two gas-discharge tubes, and two transient-voltage-suppressor diodes. The RS-485 evaluation board 2 includes transient-blocking units, high-speed protectors,

metal-oxide varistors, and transient-voltage suppressors. The boards streamline the evaluation of circuit devices on RS-485 ports, enabling designers to determine their circuits' protection needs. The boards are available through distributors Farnell, Digi-Key, and Mouser, with example prices of \$20 (10).

**Bourns Inc.**, [www.bourns.com](http://www.bourns.com)

## Maxim MAX16919 and MAX16969 USB devices protect automotives

↘ The MAX16919 and MAX16969 high-speed USB 2.0 automotive-grade protectors feature iPod/iPhone fast-charge detection and USB-host-charger detection for all USB gadgets.



**EDN**  
VOICE OF THE ENGINEER

## Customize Your Reprints!



REPRINTS  
EPRINTS  
PLAQUES  
POSTERS

Reprints can be used in:

- Trade Show Handouts
- Media Kits
- Point-of-Purchase Displays
- Direct Mail Campaigns

**Create** a powerful statement for your product, service or company through professionally designed marketing materials utilizing editorial content from *EDN*.

**Contact Wright's Media** to discuss how we can customize these materials to enhance your current marketing campaign.

**U.S.** copyright laws protect against unauthorized use of published content.


**Call today**  
**877-652-5295**  
**and allow our**  
**reprint coordinator**  
**to assist you with**  
**some proven**  
**marketing ideas.**

The devices support both 480-Mbps high-speed and 12-Mbps full-speed detection, which lets users recharge their USB devices while driving. The devices include short-to-battery and short-to-ground protection for automotive radio, navigation, connectivity, and USB-hub applications and feature  $\pm 15$ -kV-human-body-model,  $\pm 15$ -kV-air-gap, and  $\pm 8$ -kV-contact ESD protection. Operating at a  $-40$  to  $+105^\circ\text{C}$  temperature range, they come in a 16-pin,  $3.9 \times 4.94$ -mm package. The MAX16919 and MAX16969 sell for \$1.95 and \$2.15 (1000), respectively. The vendor also offers system-level modeling and simulation support.

**Maxim Integrated Products,**  
www.maxim-ic.com



## Linear LTC4366 surge-stopper IC clamps more than 500V

 The LTC4366 floating surge-stopper IC operates from 9 to more than 500V, employing an adjustable topology to allow for high-voltage operation that is independent of the IC's voltage rating. The breakdown rating of the associated resistors and MOSFETs sets the maximum operating voltage. The device uses two internal shunt resistors that work with external voltage-dropping resistors to generate the IC's supply rails. The LTC4366-1 latches and stays latched after a fault; the LTC4366-2 version automatically retries after a cool-down period of 9 sec. In shutdown mode, the LTC4366's supply current drops to less than  $20 \mu\text{A}$ . The device comes in eight-lead TSOT and  $3 \times 2$ -mm DFN packages and is available in 0 to  $70^\circ\text{C}$  commercial,  $-40$  to  $+85^\circ\text{C}$  industrial, and  $-65$  to  $+150^\circ\text{C}$  automotive temperature options. Prices start at \$2.65 (1000).

**Linear Technology Corp,**  
www.linear.com

[www.edn.com]

## EDN ADVERTISER INDEX

Company	Page	Company	Page
Advanced Interconnections	11	International Rectifier	3
Agilent Technologies	8,22,C-3	Keystone Electronics	29
Analog Devices	13	Linear Technology	C-4
Arrow Americas Components	21	MathWorks	17
Avnet	53	Maxim Integrated Products	49
Avtech Electrosystems	57	Memory Protection Devices	19
Coilcraft	4	Mouser Electronics	6
Digi-Key Corp	C-1, C-2	NIC Components Corp	55
Everlight Electronics Co Ltd	40	Pico Electronics Inc	7, 43
Front Panel Express LLC	11	RF Monolithics Inc	15, 39
Hapro Inc	57	Signal Consulting	28
Interconnect Systems Inc	27	UBM EDN	25,38, 56

EDN provides this index as an additional service. The publisher assumes no liability for errors or omissions.

# EDN product mart

This advertising is  
for new and  
current products.

**HAMEG®**  
Instruments  
A Rohde & Schwarz Company



from  
**\$1,756**

**25MHz / 50MHz  
Arbitrary Function Generator**  
HMF2525 | HMF2550

- Frequency Range  $10 \mu\text{Hz}$ ...25MHz [50MHz]
- Output Voltage  $5\text{mV}_{\text{pp}}$ ... $10\text{V}_{\text{pp}}$  (into  $50\Omega$ )  
DC Offset  $\pm 5\text{mV}$ ... $5\text{V}$
- Arbitrary Waveform Generator:  
250MSa/s, 14 Bit, 256kPts

**HAPRO Electronics**  
Tel: +1-516-794-4080 · www.hameg.us

## Fast Pulse Test Solutions from AVTECH

Avtech offers over 500 standard models of high-speed pulse generators, function generators, and amplifiers ideal for both R&D and automated factory-floor testing.

Typical Output Waveform  
2 A/div, 40 ns/div

AVR-CD1-B Reverse Recovery Test System



Some of our standard models:

- AVR-EB4-B:** +2A / -4A pulser for diode reverse-recovery time tests
- AV-156F-B:** +10 Amp constant current pulser for airbag initiator tests
- AVO-9A-B:** 200 mA, 200 ps rise time driver for pulsed laser diode tests
- AV-151J-B:**  $\pm 400\text{V}$ , 50 kHz function generator for piezoelectric tests
- AVOZ-D2-B:** 700 V, 70 A pulser for production testing of attenuators
- AVR-DV1-B:** 1000 V, variable rise-time pulser for phototriac  $dV/dt$  tests

E-mail us at: info@  
avtechpulse.com

Pricing, manuals, datasheets: [www.avtechpulse.com](http://www.avtechpulse.com)

**AVTECH ELECTROSYSTEMS LTD.** | Tel: 888-670-8729  
PO Box 265 Ogdensburg, NY 13669 | Fax: 800-561-1970



## Smack attack



**A**fter graduating from college in 1976 with my brand-new bachelor's degree in electrical engineering, I went to work for a small southern California company that produced telephone-usage-monitoring equipment. My responsibilities included those of a junior engineer, technician, purchasing agent, and assemblyman. (The company was really small.) Our first product connected to phone lines in large corporate phone systems and recorded the number of calls placed and total off-hook time. This monitoring allowed the accounting department to compare phone bills with actual usage and to catch any overcharges or abuse of phone usage.

Each unit was in a plastic box that measured about 8×12×3 in. and contained a handful of ICs; a PCB; a transformer; a 5V-dc supply; and a wheeled counter and timer, both 120V ac. A circular connector at the top of the unit mated with a phone-company-installed socket. We could view the counter and timer's wheels through slots in an aluminum front panel. During testing, these units performed flawlessly, both in our lab and at a few smaller beta test sites. When we started to perform larger installations, however, we received some complaints. The counter would

show two, three, or four calls when only one had actually occurred. We confirmed this information by comparing timer information with the number of calls; the average call was just too short.

I received the unenviable job of trying to solve the problem on-site. I drove to the company, which had more than 10,000 employees; checked in at the front desk; and was escorted to the phone-equipment room. This hot and humid room contained what looked like a million punch blocks and an infinite amount of wire covering every square inch. Our units—all clicking merrily

away—were hanging from several hundred sockets. At random, I watched one unit, and, sure enough, I saw the counter advance two or three times in quick succession. I disconnected this unit and brought it back to our lab for troubleshooting. Yet, try as I might, I could never get it to fail, despite subjecting the unit to heat, humidity, and occasional sharp smacks with the palm of my hand. Talk about abuse!

Reinstalling the unit produced the expected result: random counts. Switching this unit with another may or may not solve the problem. In other words, this problem was random and intermittent—every engineer's nightmare.

So the burning of the midnight oil began. Because we could not replicate the failure in our lab, we reinstalled the units at the customer's site. At one point, we had 20 more bypass capacitors than ICs on the board. We redesigned the 5V power supply. Nothing worked.

One day, staring at the PCB with bloodshot eyes, I noticed that one of the PCB traces for the counter ran under one of the ICs. This line carried 120V ac. Having this line run under the IC was clearly not good design practice. I removed the trace and replaced it with a piece of wire routed away from the PCB. We reinstalled the unit, and—voilà—it worked.

As the junior engineer, I was assigned the task of sitting in the hot and humid equipment room with my X-acto knife and soldering iron, making repairs at the site. A week later, all of the units were working perfectly.

We never determined why the units failed at the site but not in our lab, but we suspected that the ac spike from the counter's firing coupled into the IC was just below the threshold at which a false signal would occur. Something at the site had pushed the signal to the limit, perhaps because of the phenomenal number of wires, with their attendant radiated noise, covering the entire facility. Proper and careful PCB layout could have averted this problem. **EDN**

*Terry Staler is president of Specialty Concepts Inc (Chatsworth, CA). He treats newbie engineers with great respect.*



**"I need a function generator that generates confidence, too."**



## Point-by-point technology = more confidence.

You're developing new technologies every day that are faster, more efficient and imaginative. Agilent 33520 Series function/arbitrary waveform generators provide your waveforms with the highest signal fidelity.

With 10x better jitter than anything in its class you have unparalleled control of signal frequency. And point-by-point technology provides an unprecedented ability to generate arbitrary waveforms. That's confidence. That's Agilent.



Scan the QR code or visit <http://goo.gl/lgtJk> to see a 33500 Series product tour

© 2011 Agilent Technologies, Inc.

### 33521A and 33522A

30 MHz sine, square, pulse bandwidth

250 MSa/s, 16-bit sampling

Point-by-point arbitrary waveforms

Dual-channel coupling and tracking

**Agilent and our  
Distributor Network**  
*Right Instrument.  
Right Expertise.  
Delivered Right Now.*



800-463-9275  
[www.newark.com/agilent](http://www.newark.com/agilent)

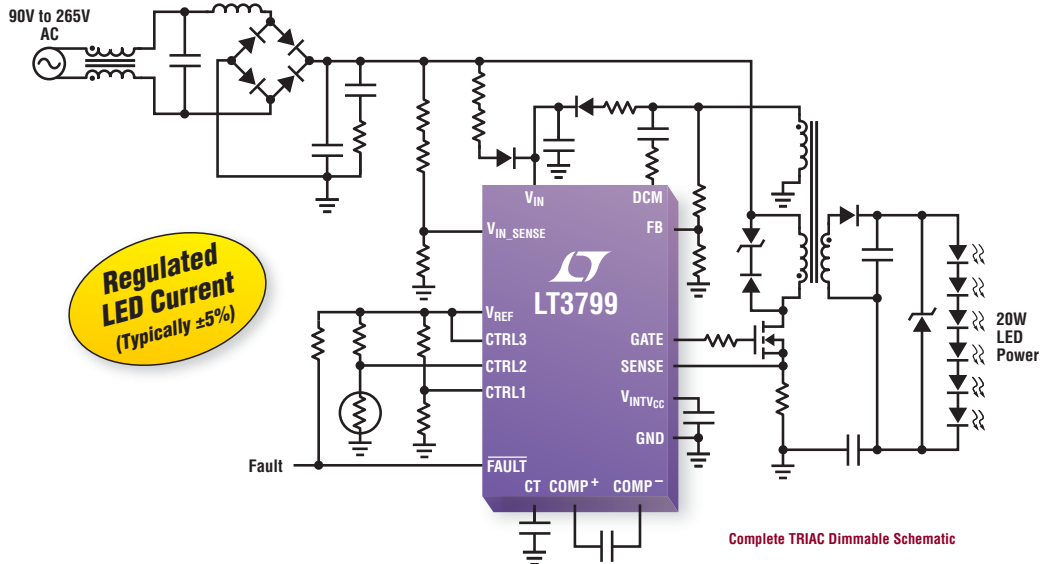
element14

**Get NEW App Note: Compare Direct Digital Synthesis vs. Point-by-Point Function Generator Performance**  
[www.newark.com/Agilent\\_Function\\_Generator](http://www.newark.com/Agilent_Function_Generator)



**Agilent Technologies**

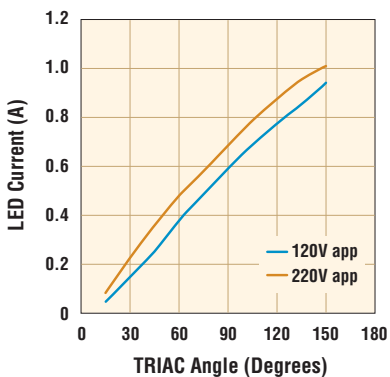
# Isolated LED Current Control with Active PFC



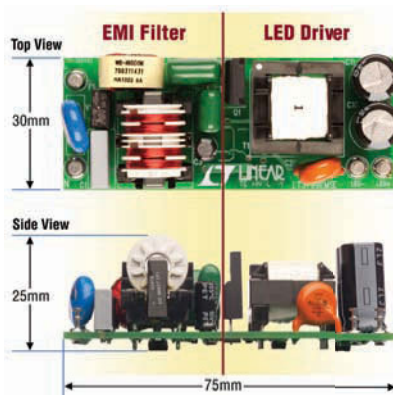
## TRIAC Dimmable LED Driver Needs No Opto-coupler

Our LT<sup>®</sup>3799 isolated LED controller with active power factor correction (PFC) is specifically designed for driving LEDs over a wide input range of 24V to 480V+. It is ideal for LED applications requiring 4W to over 100W of LED power and is compatible with standard TRIAC in-wall dimmers. The LT3799's unique current sensing scheme delivers a well regulated current to the secondary side with no opto-coupler, enabling it to provide  $\pm 5\%$  LED current accuracy. It also offers low harmonic distortion while delivering efficiencies as high as 90%. Open and short LED protection ensures long term reliability and a simple, compact solution footprint addresses a wide range of applications.

LED Current vs TRIAC Angle



LT3799 Demo Board (25W)



### Info & Free Samples

[www.linear.com/product/LT3799](http://www.linear.com/product/LT3799)

1-800-4-LINEAR



Free Power Management for LEDs Brochure

[www.linear.com/ledsolutions](http://www.linear.com/ledsolutions)

LT, LT, LTC, LTM, Linear Technology and the Linear logo are registered trademarks of Linear Technology Corporation. All other trademarks are the property of their respective owners.

